

Step into a  
**Safer World**  
**EXORA**



**Maximum Retail Prices**  
**For Final Distribution Products - EXORA**  
*Effective from 01 - 01 - 2019*

## About L&T

Larsen & Toubro is a technology-driven company that infuses engineering with imagination. The Company offers a wide range of advanced solutions in the field of Engineering, Construction, Electrical & Automation, Machinery and Information Technology.

L&T Switchgear, a part of the Electrical & Automation business, is India's largest manufacturer of low voltage switchgear, with the scale, sophistication and range to meet global benchmarks. With over five decades of experience in this field, the Company today enjoys a leadership position in the Indian market with a growing international presence.

It offers a complete range of products including powergear, controlgear, industrial automation, building electricals & automation, reactive power management, energy meters, and protective relays. These products conform to Indian and International Standards.

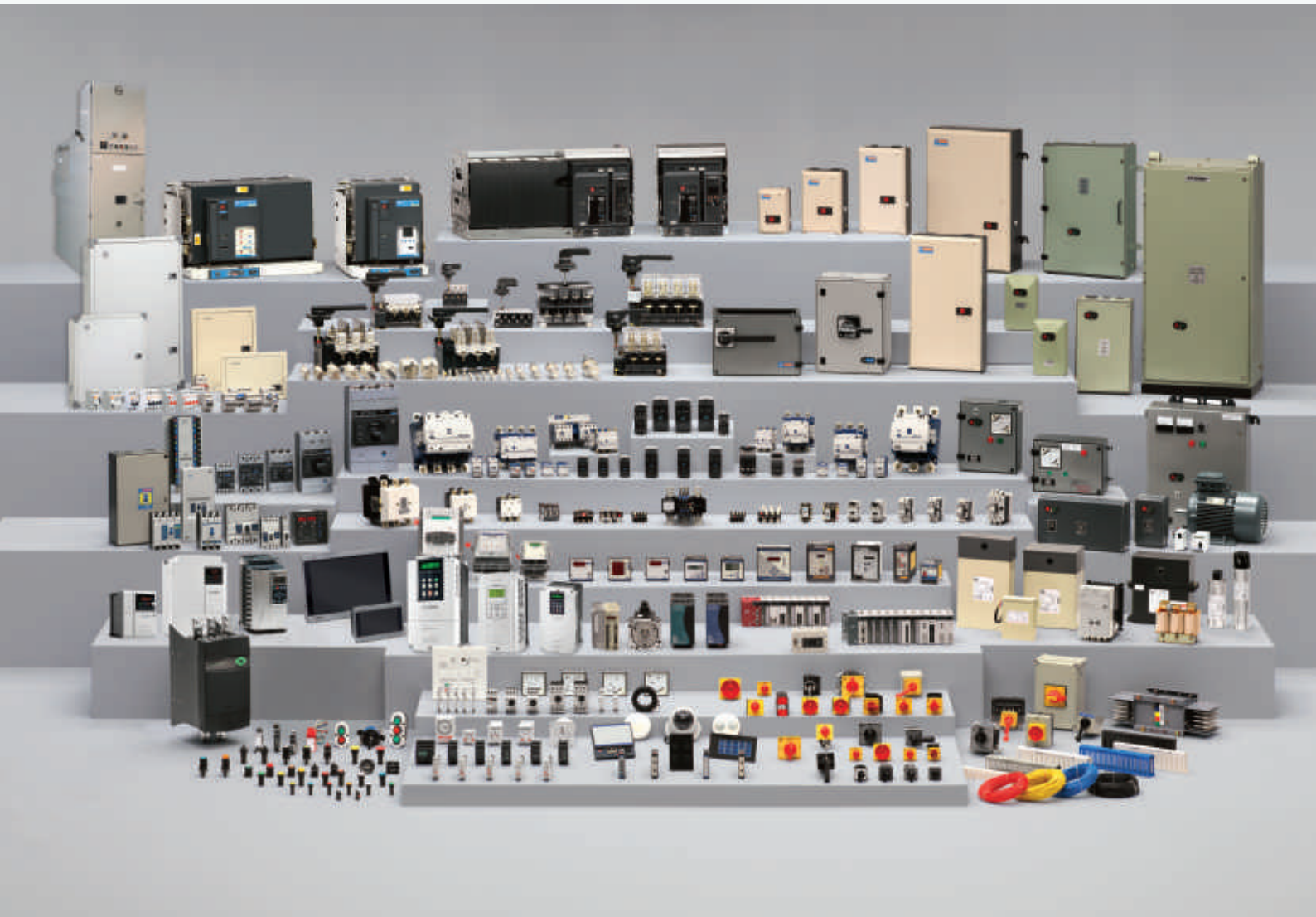



# L&T Final Distribution Products





L&T's range of modular devices offer MCB, RCCB, Isolator & DB for final distribution of electrical power. L&T's products are better known for reliability, functionality & ease of use.



## L&T Final Distribution Products spell world class

L&T products conform to relevant global standards viz. IEC, EN. They also have BIS, CE marking, CB and KEMA certification.

## Contents

MCB - Miniature Circuit Breaker -----	4	
RCCB - Residual Current Circuit Breaker -----	6	
Isolators -----	7	
Other Protection & Control Devices -----	7	
Distribution Boards -----	13	

**Note:**

Colour of HSN code signifies below  
[Green colour : 18%\* GST]

\*Subject to change as per Govt. notification





**Safety re-defined**

Finger proof terminals eliminate chances of accidental contact with live part. You can install, operate and maintain modular device with total confidence.

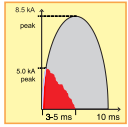

**Energy limiting class - 3**

If fault occurs, the Rapid Arc Quenching mechanism in modular device operates and extinguishes the arc quickly (within 3-5 msec), ensuring lowest possible energy flow through the circuit. This minimize risk of fire and maximizes life of your equipment.



**Safety meets superior aesthetics**

Ergonomically designed, profiled for superior cooling and manufactured with fire retardant material. Modular device is brought to you keeping in mind utmost user safety.



**Key Benefits**



**True contact indication**

L&T modular device range enhances safety through true contact indication even from a distance regardless of its mounting and knob position. Red and Green indication tags provided below the knob positively identify the electrical ON/OFF status, reflecting actual contact status.



**Integrated label holder**

L&T MCBs are equipped with label holder for easy identification of circuit during operation as well as in maintenance.



**Innovatively profiled breathing channels**

When two or more poles are placed adjacent to each other, the breathing channels are so profiled that the air circulates around individual pole, resulting in cooler operation.



**Large terminal size and dual termination**

L&T MCBs can easily accommodate cables of up to 35 sq. mm. The terminals are designed to facilitate termination of cable or bus bar or both at incomer side.



**Two position DIN rail clip**

Installation on a DIN rail is further simplified with a two-position DIN rail clip as a standard feature. L&T MCB range makes mounting on a standard DIN rail more convenient than most.



**Non-welding contacts**

Silver Graphite contact tips ensure higher life and maximum safety against contact welding due to its superior anti-welding properties, enhancing safety and life of the system.



**Combihead screw**

L&T modular devices with combihead screws, allow you to use standard as well as Philips head screw drivers. L&T modular device range addresses your undefined needs.



# MCB (10kA)

## Miniature Circuit Breaker [8536]



- True contact indication for individual pole
- Label holder facility for all configurations
- Conforms to IS/IEC 60898 - 10kA
- Conforms to IEC 60947 - 2
  - 15kA C-curve till 40 A
  - 10kA C-curve for 50A, 63A
- Available in B, C & D curves
- Low watt loss - almost 50% of the values prescribed by IS/IEC 60898
- Trip free mechanism
- Design based on advanced current limiting hammer trip mechanism
- No Line-Load bias
- Suitable for accessory fitment

Rating	Modules 1 Mod = 17.5 mm	B-Curve Cat. No.	M.R.P. (₹) Per Unit	C-Curve Cat. No.	M.R.P. (₹) Per Unit	D-Curve Cat. No.	M.R.P. (₹) Per Unit
<b>Single Pole (SP)</b>							
0.5A	1	-	-	BB10E50C	330	BB10E50D	335
1A	1	-	-	BB10010C	330	BB10010D	335
2A	1	-	-	BB10020C	330	BB10020D	335
3A	1	-	-	BB10030C	330	BB10030D	335
4A	1	-	-	BB10040C	330	BB10040D	335
6A	1	BB10060B	216	BB10060C	216	BB10060D	285
10A	1	BB10100B	216	BB10100C	216	BB10100D	285
16A	1	BB10160B	216	BB10160C	216	BB10160D	285
20A	1	BB10200B	216	BB10200C	216	BB10200D	285
25A	1	BB10250B	216	BB10250C	216	BB10250D	285
32A	1	BB10320B	216	BB10320C	216	BB10320D	285
40A	1	BB10400B	490	BB10400C	490	BB10400D	515
50A	1	BB10500B	490	BB10500C	490	BB10500D*	515
63A	1	BB10630B	490	BB10630C	490	BB10630D*	515



### Double Pole (DP)

0.5A	2	-	-	BB20E50C	900	BB20E50D	915
1A	2	-	-	BB20010C	900	BB20010D	915
2A	2	-	-	BB20020C	900	BB20020D	915
3A	2	-	-	BB20030C	900	BB20030D	915
4A	2	-	-	BB20040C	900	BB20040D	915
6A	2	BB20060B	675	BB20060C	675	BB20060D	695
10A	2	BB20100B	675	BB20100C	675	BB20100D	695
16A	2	BB20160B	675	BB20160C	675	BB20160D	695
20A	2	BB20200B	675	BB20200C	675	BB20200D	695
25A	2	BB20250B	675	BB20250C	675	BB20250D	695
32A	2	BB20320B	675	BB20320C	675	BB20320D	695
40A	2	BB20400B	1090	BB20400C	1090	BB20400D	1130
50A	2	BB20500B	1090	BB20500C	1090	BB20500D*	1130
63A	2	BB20630B	1090	BB20630C	1090	BB20630D*	1130



### Three Pole (TP)

0.5A	3	-	-	BB30E50C	1265	BB30E50D	1280
1A	3	-	-	BB30010C	1265	BB30010D	1280
2A	3	-	-	BB30020C	1265	BB30020D	1280
3A	3	-	-	BB30030C	1265	BB30030D	1280
4A	3	-	-	BB30040C	1265	BB30040D	1280
6A	3	BB30060B	1100	BB30060C	1100	BB30060D	1130
10A	3	BB30100B	1100	BB30100C	1100	BB30100D	1130
16A	3	BB30160B	1100	BB30160C	1100	BB30160D	1130
20A	3	BB30200B	1100	BB30200C	1100	BB30200D	1130
25A	3	BB30250B	1100	BB30250C	1100	BB30250D	1130
32A	3	BB30320B	1100	BB30320C	1100	BB30320D	1130
40A	3	BB30400B	1695	BB30400C	1695	BB30400D	1755
50A	3	BB30500B	1695	BB30500C	1695	BB30500D*	1755
63A	3	BB30630B	1695	BB30630C	1695	BB30630D*	1755



Note: Standard Pack Quantity for MCB : SP - 12 Nos., DP - 6 Nos., TP - 4 Nos., FP - 3 Nos.

\* For details, please contact L&T branch office





Rating	Modules 1 Mod = 17.5 mm	B-Curve Cat. No.	M.R.P. (₹) Per Unit	C-Curve Cat. No.	M.R.P. (₹) Per Unit	D-Curve Cat. No.	M.R.P. (₹) Per Unit
<b>Four Pole (FP)</b>							
0.5A	4	-	-	BB40E50C	1740	BB40E50D	1760
1A	4	-	-	BB40010C	1740	BB40010D	1760
2A	4	-	-	BB40020C	1740	BB40020D	1760
3A	4	-	-	BB40030C	1740	BB40030D	1760
4A	4	-	-	BB40040C	1740	BB40040D	1760
6A	4	BB40060B	1490	BB40060C	1490	BB40060D	1505
10A	4	BB40100B	1490	BB40100C	1490	BB40100D	1505
16A	4	BB40160B	1490	BB40160C	1490	BB40160D	1505
20A	4	BB40200B	1490	BB40200C	1490	BB40200D	1505
25A	4	BB40250B	1490	BB40250C	1490	BB40250D	1505
32A	4	BB40320B	1490	BB40320C	1490	BB40320D	1505
40A	4	BB40400B	2115	BB40400C	2115	BB40400D	2170
50A	4	BB40500B	2115	BB40500C	2115	BB40500D*	2170
63A	4	BB40630B	2115	BB40630C	2115	BB40630D*	2170

Note: Standard Pack Quantity for MCB : SP - 12 Nos., DP - 6 Nos., TP- 4 Nos., FP - 3 Nos.

### DC MCBs as per IEC 60947-2 [8536]

Rated Voltage:130V DC (for SP), 250V DC (for DP)  
with breaking capacity of 6 kA

Rated Voltage:250V DC (for SP), 500V DC (for DP)  
with breaking capacity of 10 kA



Rating	Modules 1 Mod = 17.5mm	Cat. No.	M.R.P. (₹) Per Unit
<b>Single Pole</b>			
0.5A	1	BB10E5DC	485
1A	1	BB1001DC	485
2A	1	BB1002DC	485
3A	1	BB1003DC	485
4A	1	BB1004DC	485
6A	1	BB1006DC	415
10A	1	BB1010DC	415
16A	1	BB1016DC	415
20A	1	BB1020DC	415
25A	1	BB1025DC	415
32A	1	BB1032DC	415
40A	1	BB1040DC	540
50A	1	BB1050DC	540
63A	1	BB1063DC	540



#### Single Pole

Rating	Modules 1 Mod = 17.5mm	Cat. No.	M.R.P. (₹) Per Unit
0.5A	1	BJ10E5DC	*
1A	1	BJ1001DC	*
2A	1	BJ1002DC	*
3A	1	BJ1003DC	*
4A	1	BJ1004DC	*
6A	1	BJ1006DC	*
10A	1	BJ1010DC	*
16A	1	BJ1016DC	*
20A	1	BJ1020DC	*
25A	1	BJ1025DC	*
32A	1	BJ1032DC	*
40A	1	BJ1040DC	*



Rating	Modules 1 Mod = 17.5mm	Cat. No.	M.R.P. (₹) Per Unit
<b>Double Pole</b>			
0.5A	2	BB20E5DC	985
1A	2	BB2001DC	985
2A	2	BB2002DC	985
3A	2	BB2003DC	985
4A	2	BB2004DC	985
6A	2	BB2006DC	865
10A	2	BB2010DC	865
16A	2	BB2016DC	865
20A	2	BB2020DC	865
25A	2	BB2025DC	865
32A	2	BB2032DC	865
40A	2	BB2040DC	1160
50A	2	BB2050DC	1160
63A	2	BB2063DC	1160



#### Double Pole

Rating	Modules 1 Mod = 17.5mm	Cat. No.	M.R.P. (₹) Per Unit
0.5A	2	BJ20E5DC	*
1A	2	BJ2001DC	*
2A	2	BJ2002DC	*
3A	2	BJ2003DC	*
4A	2	BJ2004DC	*
6A	2	BJ2006DC	*
10A	2	BJ2010DC	*
16A	2	BJ2016DC	*
20A	2	BJ2020DC	*
25A	2	BJ2025DC	*
32A	2	BJ2032DC	*
40A	2	BJ2040DC	*

Note: Standard Pack Quantity for MCB :  
SP - 12 Nos., DP - 6 Nos.

\* For details, please contact L&T branch office



### Auxiliary & Accessories for MCBs [8538]

Description	Cat. No.	M.R.P. (₹) Per Unit
AUXILIARY CONTACT - 6A , 240V AC, (1NO+1NC), 0.5 MOD	BZA11006	705
SHUNT RELEASE - 240V AC, 1 MOD	BZS00240	1880
TRIP ALARM CONTACT - 6A, 240V AC, (1NO+1NC), 0.5 MOD	BZT11006	820

# RCCB

## Residual Current Circuit Breaker



- Conforms to IS 12640 (Part 1) / IEC 61008-1
- RCCBs are available in DP and FP versions from 25 to 100A ratings with 30 mA, 100 mA and 300 mA sensitivity
- Truly current operated - operation even at nominal voltage
- Operates on Core Balance Current Transformer (CBCT) principle
- Operation even in case of neutral failure
- Advanced neutral mechanism

Current Rating (In)	Sensitivity	Modules 1 Mod = 17.5 mm	Cat. Nos.	M.R.P. (₹) Per Unit
<b>Double Pole (DP)</b>				
25A	30 mA	2	BG202503	2405
	100 mA	2	BG202510	2520
	300 mA	2	BG202530	2520
40A	30 mA	2	BG204003	2720
	100 mA	2	BG204010	2880
	300 mA	2	BG204030	2880
63A	30 mA	2	BG206303	3390
	100 mA	2	BG206310	3475
	300 mA	2	BG206330	3475
100A	30 mA	2	BG210003	5950
	100 mA	2	BG210010	6030
	300 mA	2	BG210030	6030
<b>Four Pole (FP)</b>				
25A	30 mA	4	BG402503	3185
	100 mA	4	BG402510	3300
	300 mA	4	BG402530	3300
40A	30 mA	4	BG404003	3195
	100 mA	4	BG404010	3350
	300 mA	4	BG404030	3350
63A	30 mA	4	BG406303	3670
	100 mA	4	BG406310	3850
	300 mA	4	BG406330	3850
100A	30 mA	4	BG410003	6435
	100 mA	4	BG410010	6550
	300 mA	4	BG410030	6550



# Isolators [8536]

- Conforms to IEC 60947-3
- Utilization category AC-22A
- Available in DP, TP and FP versions in 40A, 63A, 80A & 100A ratings

Current Rating (In)	Modules 1 Mod = 17.5 mm	Cat. Nos.	M.R.P. (₹) Per Unit
<b>Double Pole (DP)</b>			
40A	2	BF204000	400
63A	2	BF206300	515
80A	2	BF208000	655
100A	2	BF210000	690
<b>Three Pole (TP)</b>			
40A	3	BF304000	705
63A	3	BF306300	815
80A	3	BF308000	900
100A	3	BF310000	910
<b>Four Pole (FP)</b>			
40A	4	BF404000	920
63A	4	BF406300	935
80A	4	BF408000	1060
100A	4	BF410000	1125



Note: Standard Pack Quantity for Isolator : DP - 6 Nos., TP - 4 Nos., FP - 3 Nos.



## Single Phase -ACCL [8536]

### Automatic Changeover with Current Limiter

- Conforms to IEC 60947-6, IEC 60947-3
- Wide Range of Current Ratings
  - (Generator side) - 1.5A to 30A
  - (Electricity Board side) - 30A
- RoHS compliant

Description	Module	Cat. Nos.	M.R.P. (₹) Per Unit
30A/1.5A	4	AUCL010301E5	1935
30A/2.5A	4	AUCL010302E5	1935
30A/3A	4	AUCL01030003	1935
30A/4A	4	AUCL01030004	1935
30A/5A	4	AUCL01030005	1935
30A/6A	4	AUCL01030006	1935
30A/8A	4	AUCL01030008	1935
30A/10A	4	AUCL01030010	1935
30A/12A	4	AUCL01030012	1935
30A/15A	4	AUCL01030015	1935
30A/20A	4	AUCL01030020	1935
30A/30A	4	AUCL01030030*	1935





# Modular Contactors [8536]

- Wide Range of Current Ratings
  - 25A, 40A and 63A
- Conforms to:
  - IEC 61095, EN 61095
  - IEC 60497-4-1, EN 60497-4-1
  - IEC 60497-5-1
- Available in:
  - 1NO, 2NO, 3NO, 4NO and 2NO+2NC version
- Protection Degree IP 20

Description (AC-1)	Module	Cat. Nos.	M.R.P. (₹) Per Unit
25A-1NO	1	AUMC1002501	1340
25A-2NO	1	AUMC2002501	1670
40A-2NO	3	AUMC2004003	2870
40A-3NO	3	AUMC3004003	4010
40A-4NO	3	AUMC4004003	4800
63A-2NO+2NC	3	AUMC2206303	5100
63A-3NO	3	AUMC3006303	5200
63A-4NO	3	AUMC4006303	5720
Accessory [8538]			
Auxiliary Contact, 2NO	0.5	AUMCAUX240	1600



# Changeover Switches [8536]

- Conforms to IEC 60947-3 and IS/IEC 60947-3
- Utilization category AC-22A
- Available in 3 positions (I-O-II) with centre off position

Description	Module	Cat. Nos.	M.R.P. (₹) Per Unit
<b>Double Pole</b>			
25A	2	AUC00202500	1405
40A	2	AUC00204000	2155
63A	3	AUC00206300	2505
<b>Four Pole</b>			
40A	4	AUC00404000	3710
63A	6	AUC00406300	4210



# Indicating Lights [8531]

Description	Module	Cat. Nos.	M.R.P. (₹) Per Unit
RED	1	AUIL01RED00	830
YELLOW	1	AUIL01YEL00	830
BLUE	1	AUIL01BLU00	830
GREEN	1	AUIL01GRE00	830
RED-YELLOW-BLUE	1	AUIL01RYB00	1005



# Energy Meters [9030]

- Communication with additional RS485 & WiFi module
- Class 1 accuracy
- Direct current operated meter
- Reverse current indication for three-phase meter

Description	Module	Cat. Nos.	M.R.P. (₹) Per Unit
Single Phase (5-40A)	2	WD4000101000	2035
Three Phase (10-60A)	7	WD4000103000	4620



# MCB (Miniature Circuit Breakers) : 80A-125A [8536]

- Short circuit Breaking Capacity - 15kA (IEC 60947-2, EN 60947-2)
- C & D Characteristics
- Available in SP, DP, TP and FP
- Suitable for Isolation
- Protection Degree - IP 20
- Availability of wide Range of Site Mountable Accessories

Rating	Module	C Curve Cat. No.	M.R.P. (₹) Per Unit
<b>Single Pole</b>			
80A	1.5	AU15S10803C	1975
100A	1.5	AU15S11003C	2210
125A	1.5	AU15S11253C	2380

<b>Two Pole</b>			
80A	3	AU15S20803C	4370
100A	3	AU15S21003C	4665
125A	3	AU15S21253C	5135

<b>Three Pole</b>			
80A	4.5	AU15S30803C	6900
100A	4.5	AU15S31003C	7355
125A	4.5	AU15S31253C	8160

<b>Four Pole</b>			
80A	6	AU15S40803C	9010
100A	6	AU15S41003C	9375
125A	6	AU15S41253C	10605



D Curve Cat. No.	M.R.P. (₹) Per Unit
AU15S10803D	2090
AU15S11003D	2345
AU15S11253D	2535

AU15S20803D	4645
AU15S21003D	4955
AU15S21253D	5445

AU15S30803D	7325
AU15S31003D	7805
AU15S31253D	8655

AU15S40803D	9545
AU15S41003D	9950
AU15S41253D	11255

# SPD (Surge Protection Devices) [8536]

- Conforms to IEC 61643-11
- Available in Type 2 and Type 1+2
- Type 2 : Protection against indirect lightning and switching surges
  - Maximum Discharge Current - I<sub>max</sub> up to 70kA
- Type 1+2 : Protection against direct and indirect lightning surges
  - Maximum Discharge Current - I<sub>max</sub> up to 100kA



Description	Configuration	Module	Cat. No.	M.R.P. (₹) Per Unit
Type 1+2, I <sub>max</sub> 50kA	1P+N	2	AUSP121PN50	10800
	3P+N	4	AUSP123PN50	21200
Type 2, I <sub>max</sub> 40kA	1P+N	1	AUSP021PN40	7500
	3P+N	2	AUSP023PN40	15000
Type 2, I <sub>max</sub> 15kA	1P+N	1	AUSP021PN15	6000
	3P+N	2	AUSP023PN15	11800
Type 1+2, I <sub>max</sub> 100kA	1P+N	2	AUSP121PN100	12000
	3P+N	4	AUSP123PN100	22000
Type 2, I <sub>max</sub> 70kA	1P+N	2	AUSP021PN70	12000
	3P+N	4	AUSP023PN70	20000

<b>New</b>	Description	Cat. No.	M.R.P. (₹) Per Unit
	Cartridge for AUSP021PN15	AUSC021PN15	1800
	Cartridge for AUSP021PN40	AUSC021PN40	2250
	Cartridge for AUSP021PN70 / AUSP023PN70	AUSC021PN70	2400
	Cartridge for AUSP023PN15	AUSC023PN15	2360
	Cartridge for AUSP023PN40	AUSC023PN40	3000
	Cartridge for AUSP121PN100 / AUSP123PN100	AUSC121PN100	3600
	Cartridge for AUSP121PN50 / AUSP123PN50	AUSC121PN50	3455

# RCBOs (Residual Current Breaker with Overcurrent Protection)\* [8536]

- Conforms to IEC 61009-1, IS 12640-2, EN 61009-1
- Short circuit Breaking Capacity - 10kA
- Precise Sensitivities for a variety of applications  
- from 10mA to 300mA
- Suitable for Isolation

- Availability of wide Range of Site Mountable Accessories
- Available in  
- Type AC : For standard AC installations  
- Type Adi : Suitable for AC + Pulsating DC (Type A) + Harmonics

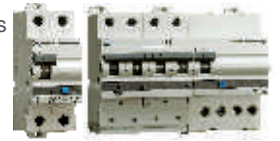

## Type-AC

Rating	Sensitivity	Module	CAT Nos.	M.R.P. (₹) Per Unit
<b>2P AC</b>				
6A	10mA	2	AUF3C200601	3625
	30mA	2	AUF3C200603	3625
	100mA	2	AUF3C200610	3705
	300mA	2	AUF3C200630	3725
10A	10mA	2	AUF3C201001	3625
	30mA	2	AUF3C201003	3625
	100mA	2	AUF3C201010	3705
	300mA	2	AUF3C201030	3725
16A	10mA	2	AUF3C201601	3625
	30mA	2	AUF3C201603	3625
	100mA	2	AUF3C201610	3705
	300mA	2	AUF3C201630	3725
20A	30mA	2	AUF3C202003	3625
	100mA	2	AUF3C202010	3705
	300mA	2	AUF3C202030	3725
25A	30mA	2	AUF3C202503	3625
	100mA	2	AUF3C202510	3705
	300mA	2	AUF3C202530	3725
32A	30mA	2	AUF3C203203	3625
	100mA	2	AUF3C203210	3705
	300mA	2	AUF3C203230	3725
40A	30mA	2	AUF3C204003	3625
	100mA	2	AUF3C204010	3705
	300mA	2	AUF3C204030	3725
63A	30mA	4	AUF3C206303	4650
	100mA	4	AUF3C206310	4925
	300mA	4	AUF3C206330	4965
<b>4P AC</b>				
16A	30mA	7.5	AUF3C401603	4205
	100mA	7.5	AUF3C401610	4675
	300mA	7.5	AUF3C401630	4770
20A	30mA	7.5	AUF3C402003	4205
	100mA	7.5	AUF3C402010	4675
	300mA	7.5	AUF3C402030	4770
25A	30mA	7.5	AUF3C402503	4205
	100mA	7.5	AUF3C402510	4675
	300mA	7.5	AUF3C402530	4770
32A	30mA	7.5	AUF3C403203	4340
	100mA	7.5	AUF3C403210	4680
	300mA	7.5	AUF3C403230	4780
40A	30mA	7.5	AUF3C404003	4405
	100mA	7.5	AUF3C404010	4680
	300mA	7.5	AUF3C404030	4795
63A	30mA	7.5	AUF3C406303	5280
	100mA	7.5	AUF3C406310	5385
	300mA	7.5	AUF3C406330	5385
80A	30mA	12	AUF3C408003	19340
	100mA	12	AUF3C408010	19770
	300mA	12	AUF3C408030	19770
100A	30mA	12	AUF3C410003	20675
	100mA	12	AUF3C410010	21170
	300mA	12	AUF3C410030	21170

## Type-Adi

Rating	Sensitivity	Module	CAT Nos.	M.R.P. (₹) Per Unit
<b>2P Adi</b>				
6A	30mA	2	AUF3D200603	4660
	100mA	2	AUF3D200610	5130
	300mA	2	AUF3D200630	5320
10A	30mA	2	AUF3D201003	4660
	100mA	2	AUF3D201010	5130
	300mA	2	AUF3D201030	5320
16A	30mA	2	AUF3D201603	4660
	100mA	2	AUF3D201610	5130
	300mA	2	AUF3D201630	5320
20A	30mA	2	AUF3D202003	4660
	100mA	2	AUF3D202010	5130
	300mA	2	AUF3D202030	5320
25A	30mA	2	AUF3D202503	4660
	100mA	2	AUF3D202510	5130
	300mA	2	AUF3D202530	5320
32A	30mA	2	AUF3D203203	4660
	100mA	2	AUF3D203210	5130
	300mA	2	AUF3D203230	5320
40A	30mA	2	AUF3D204003	4660
	100mA	2	AUF3D204010	5130
	300mA	2	AUF3D204030	5320
63A	30mA	4	AUF3D206303	5815
	100mA	4	AUF3D206310	6155
	300mA	4	AUF3D206330	6205
<b>4P Adi</b>				
16A	30mA	7.5	AUF3D401603	5255
	100mA	7.5	AUF3D401610	5845
	300mA	7.5	AUF3D401630	5965
20A	30mA	7.5	AUF3D402003	5255
	100mA	7.5	AUF3D402010	5845
	300mA	7.5	AUF3D402030	5965
25A	30mA	7.5	AUF3D402503	5255
	100mA	7.5	AUF3D402510	5845
	300mA	7.5	AUF3D402530	5965
32A	30mA	7.5	AUF3D403203	5425
	100mA	7.5	AUF3D403210	5850
	300mA	7.5	AUF3D403230	5975
40A	30mA	7.5	AUF3D404003	5505
	100mA	7.5	AUF3D404010	5850
	300mA	7.5	AUF3D404030	5995
63A	30mA	7.5	AUF3D406303	6600
	100mA	7.5	AUF3D406310	6730
	300mA	7.5	AUF3D406330	6730
80A	30mA	12	AUF3D408003	19340
	100mA	12	AUF3D408010	19770
	300mA	12	AUF3D408030	19770
100A	30mA	12	AUF3D410003	20675
	100mA	12	AUF3D410010	21170
	300mA	12	AUF3D410030	21170

\* For technical details, please contact L&T branch office

New

New

# Time Switches [9107]

Description	Module	Cat. Nos.	M.R.P. (₹) Per Unit
Analog time switch	1	AUTS01ANA00	3750
Analog time switch	3	AUTS03ANA00	4560
Digital time switch	2	AUTS02DIG00	2870
Astro time switch	2	AUTS02AST00	4820



# Accessories [8538]

All Half Module and One Module Accessories are common for 80A-125A MCBs, RCBOs and Adi RCCBs

Description	Configuration	Module	Voltage	CAT Nos.	M.R.P. (₹) Per Unit
Auxiliary Contact	1NO+1NC	0.5	240V AC, 24V DC	AUAXAC240	735
AUX/TAC*	1NO+1NC	0.5	240V AC, 24V DC	AUATAC240	865
Undervoltage Release	-	1	240V AC	AUUVAC240	1755
	-	1	24V DC	AUUVDC024	1755
Overvoltage Release	-	1	240V AC	AUOVAC240	2155
Shunt Release	-	1	240V AC	AUSRAC240	2005
	-	1	24V DC	AUSRDC024	2005
Padlock-Suitable for Lock Hasp 3.5 - 5 mm dia. max	Suitable for 1Pole=1Mod devices: RCCBs, RCBOs, Changeover Switches up to 40A			AUPD01	405
	Suitable for 1Pole-1.5Mod devices: MCBs 80A-125A, Changeover Switch 63A			AUPD02	455



Note: Standard Pack Quantity for Padlock - 2Nos.

\* For 80A-125A MCBs please contact nearest L&T branch

# RCCBs (Residual Current Circuit Breakers) [8536]

## Type-Adi (with Added immunity)

- Wide Range of Current Ratings - 25A to 100A
- Precise Sensitivities for variety of applications - from 30mA to 300mA
- 2P & 4P versions
- Suitable for Isolation

- Protection Degree - IP 20
- Availability of wide Range of Site Mountable Accessories
- Type Adi : Suitable for AC + Pulsating DC (Type A) + Harmonics

Rating	Sensitivity	Module	CAT Nos.	M.R.P. (₹) Per Unit
<b>2P Adi</b>				
25A	30mA	2	AURAD202503	3915
	100mA	2	AURAD202510	4095
	300mA	2	AURAD202530	4095
40A	30mA	2	AURAD204003	4160
	100mA	2	AURAD204010	4225
	300mA	2	AURAD204030	4225
63A	30mA	2	AURAD206303	4855
	100mA	2	AURAD206310	4950
	300mA	2	AURAD206330	4950
100A	30mA	2	AURAD210003	7180
<b>4P Adi</b>				
25A	30mA	4	AURAD402503	4730
	100mA	4	AURAD402510	4825
	300mA	4	AURAD402530	4825
40A	30mA	4	AURAD404003	4910
	100mA	4	AURAD404010	4995
	300mA	4	AURAD404030	4995
63A	30mA	4	AURAD406303	5350
	100mA	4	AURAD406310	5460
	300mA	4	AURAD406330	5460
100A	30mA	4	AURAD410003	8520
	300mA	4	AURAD410030	8520



# Experience the most robust performance of Single Phase ACCL

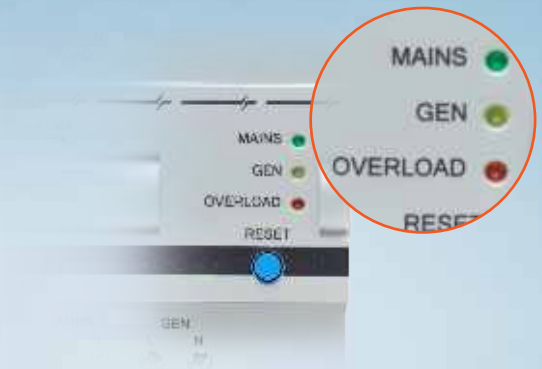
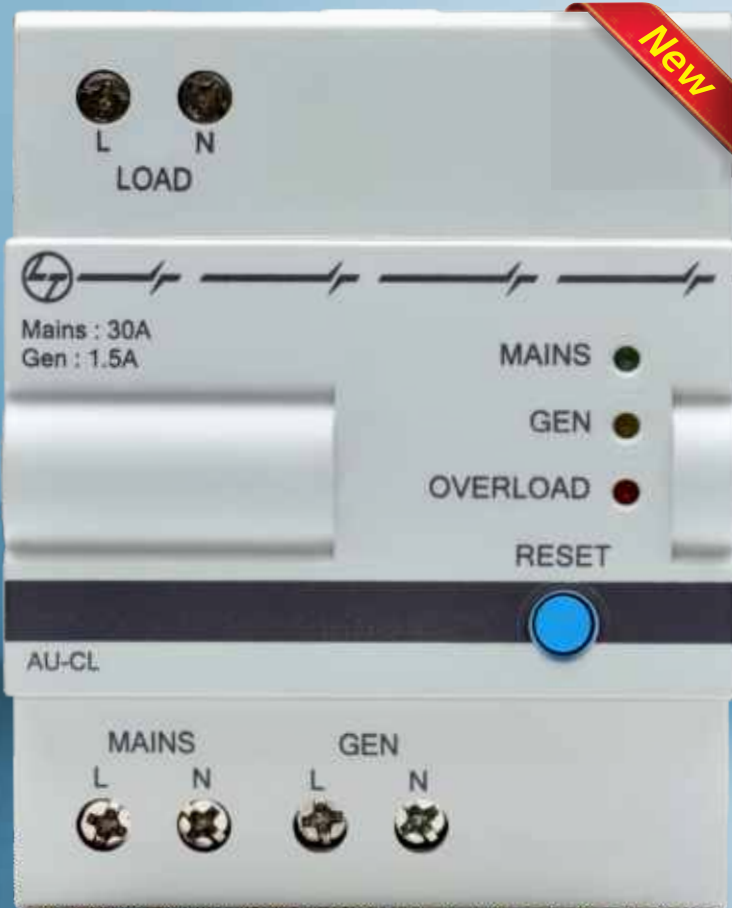

## LED Indication

Different LED colors for clear differentiation between Mains ON, Genset ON and Genset Overload

## Reset Button

To Restore the supply to load, after non essential loads are switched off

## Automatic Changeover with Current Limiter

- Reliable advanced micro-controller based design for measuring and controlling output
- Assured trouble free performance through rigorous 18 quality checks
- Extensively tested for Indian field conditions



### Customer Interaction Center (CIC)

BSNL / MTNL (toll free): 1800 233 5858 Reliance (toll free): 1800 200 5858  
Tel: 022 6774 5858 Email: cic@Lntebg.com Web: www.Lntebg.com

# New Range of Distribution Boards



## Certification

Conforms to IS 8623-1 & 3,  
IEC 61439 - 1 & 3



Protection against Mechanical Impact (IK)  
Ensures Distribution Boards and  
Enclosures are well protected from  
external impact



Ingress Protection (IP) Test certificate  
Ensures Distribution Boards and  
Enclosures are well protected against  
external foreign bodies & liquid



Complete range of Distribution Boards  
is RoHS compliant



## Customer Benefits

- In order to adapt to site condition, DB door can be reversed at the site

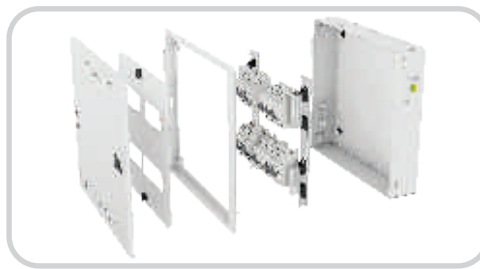

- DB Installation made convenient with independently removable door, shield, frame & chassis
- The removal of the chassis, with the neutral bar mounted on it offers immense flexibility during commissioning

- Product mounting and wiring made easy as the products can be conveniently mounted on the chassis and entire assembly can be easily fitted in the DB box with chassis that can be stored separately

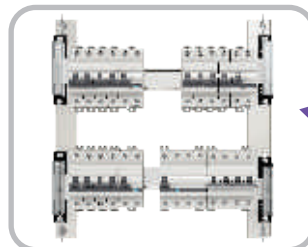
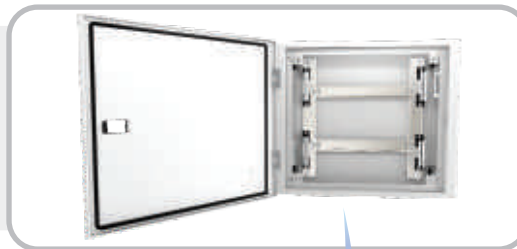

- To avoid unauthorized access to a DB and ensure safety during maintenance, DBs are equipped for installing a special latch with a key lock provision

- Flush mounting of a DB made easy and perfect fit is achieved with clearly visible anti insertion marking



## Customer Benefits

- No accidental contact with live parts is ensured with
  - Transparent shrouds for neutral bars →
  - High quality insulation on bus-bars



- Assured level of **Ingress Protection (IP)** with the help of high quality gaskets in double door DBs



- Protection of DB interiors from cement splashes during civil activities with cement spill protector



- Ease of wiring is facilitated with removable top and bottom gland plates with adequate number of cut and carry knockouts



- Removing of shield made easy with ergonomically designed holding shield knobs





## Customer Benefits



- Safe, neat and clutter-free wiring is facilitated with adequate space for wiring

- Complete safety is ensured by effective earthing throughout the distribution board with star washers

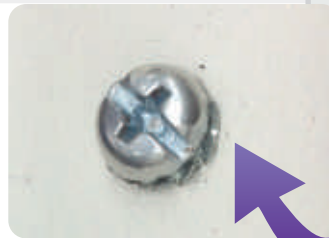

- Independently packed 'door-frame-shield' ensures-
  - Separate and safe storage at site
  - No damage during civil activities

## Customized Distribution Boards

### Prewired DBs

- Distribution Boards with factory fitted phase and neutral terminal blocks for termination of incoming and outgoing wires
- Available in both Single Phase and Three Phase DB versions



### 8 segment DBs

- Distribution Boards with phase segregation between incomer, sub incomer, outgoing and supply changeover sections



### DBs with provision for TV/Telephone Splitters

- Distribution Boards equipped with provisions to mount TV-Telephone splitters
- Available in both Single phase and Three phase DB versions



### DBs with Auto manual switches

- Distribution Boards with inbuilt auto-manual switches
- Available in both Single phase and Three phase DB versions



For any other customized requirements please contact nearest L&T branch

## SPN DB [8537]

### Highlights

- IK 08-for single door DBs, IK 09-for double door DBs
- Available in CRCA sheet steel, RAL9003, powder coated
- Ready to use DBs - Provided with 100A insulated phase bus-bar | neutral bar/s with shroud/s | earth bar/s | sticking saddles | cement spill protector | color-coded interconnecting wire set | cable ties | blanking plates and circuit identification label
- With provision for DP MCB/Isolator/RCCB/RCBO as incomer and SP MCBs as outgoing



IP 30 - Single Door      IP 43 - Metal Door      IP 43 - Glazed Door

Description	No. of Modules		Cat. Nos.	M.R.P. (₹) Per Unit
	Incomer	Outgoing		
<b>IP 30 - Single Door</b>				
4 way	2	2	DBSPN004SD	985
6 way	2	4	DBSPN006SD	1075
8 way	2	6	DBSPN008SD	1240
12 way	2	10	DBSPN012SD	1470
16 way	2	14	DBSPN016SD	1815
18 way	2	16	DBSPN018SD	2295
<b>IP 43 - Metal Door</b>				
4 way	2	2	DBSPN004DD	1355
6 way	2	4	DBSPN006DD	1560
8 way	2	6	DBSPN008DD	1675
12 way	2	10	DBSPN012DD	2020
16 way	2	14	DBSPN016DD	2530
18 way	2	16	DBSPN018DD	3300
<b>IP 43 - Glazed Door</b>				
4 way	2	2	DBSPN004GD	1700
6 way	2	4	DBSPN006GD	1810
8 way	2	6	DBSPN008GD	1975
12 way	2	10	DBSPN012GD	2390
16 way	2	14	DBSPN016GD	2970
18 way	2	16	DBSPN018GD	3445
<b>IP 54 - Metal Door</b>				
4 way	2	2	DBSPN00454	4200
6 way	2	4	DBSPN00654	4685
8 way	2	6	DBSPN00854	4940
12 way	2	10	DBSPN01254	5705
16 way	2	14	DBSPN01654	6315
18 way	2	16	DBSPN01854	6765

## TPN DB [8537]

### Highlights

- IK 08-for single door DBs, IK 09-for double door DBs
- Available in CRCA sheet steel, RAL 9003, powder coated
- Ready to use DBs - Provided with 100A insulated phase bus-bars | neutral bar/s with shroud/s | earth bar/s | sticking saddles | cement spill protector | color-coded interconnecting wire set | cable ties | blanking plates and circuit identification labels
- With provision for FP MCB/Isolator/RCCB/RCBO as incomer and SP MCBs as outgoing



IP 30 - Single Door      IP 43 - Metal Door      IP 43 - Glazed Door

Description	No. of Modules		Cat. Nos.	M.R.P. (₹) Per Unit
	Incomer	Outgoing		
<b>IP 30 - Single Door</b>				
4 way	4	4+4+4	DBTPE004SD	2545
6 way	4	6+6+6	DBTPE006SD	3125
4 way	8	4+4+4	DBTPN004SD	2730
6 way	8	6+6+6	DBTPN006SD	3365
8 way	8	8+8+8	DBTPN008SD	3960
12 way	8	12+12+12	DBTPN012SD	5865
16 way	8	16+16+16	DBTPN016SD	7225
<b>IP 43 - Metal Door</b>				
4 way	4	4+4+4	DBTPE004DD	3105
6 way	4	6+6+6	DBTPE006DD	3830
4 way	8	4+4+4	DBTPN004DD	3310
6 way	8	6+6+6	DBTPN006DD	4085
8 way	8	8+8+8	DBTPN008DD	4890
12 way	8	12+12+12	DBTPN012DD	7325
16 way	8	16+16+16	DBTPN016DD	9030
<b>IP 43 - Glazed Door</b>				
4 way	4	4+4+4	DBTPE004GD	3965
6 way	4	6+6+6	DBTPE006GD	4895
4 way	8	4+4+4	DBTPN004GD	4230
6 way	8	6+6+6	DBTPN006GD	5215
8 way	8	8+8+8	DBTPN008GD	6255
12 way	8	12+12+12	DBTPN012GD	9595
16 way	8	16+16+16	DBTPN016GD	11515
<b>IP 54 - Metal Door</b>				
4 way	4	4+4+4	DBTPE00454	9940
6 way	4	6+6+6	DBTPE00654	12260
4 way	8	4+4+4	DBTPN00454	10465
6 way	8	6+6+6	DBTPN00654	12595
8 way	8	8+8+8	DBTPN00854	13775
12 way	8	12+12+12	DBTPN01254	19415
16 way	8	16+16+16	DBTPN01654	23305

## PPI DB [8537]

### Highlights

- IK 09-for double door DBs
- Available in CRCA sheet steel, RAL 9003, powder coated
- Ready to use DBs - Provided with 100A insulated phase bus-bars | neutral bar/s with shroud/s | earth bar/s | sticking saddles | cement spill protector | color-coded interconnecting wire set | cable ties | blanking plates and circuit identification labels
- With provision for FP MCB/Isolator/RCCB/RCBO as incomer, DP RCCB/RCBO as sub-incomer and SP MCBs as outgoing



Horizontal PPI DBs

IP 43 - Metal Door

Description	No. of Modules			Cat. Nos.	M.R.P. (₹) Per Unit
	Incomer	Sub-Incomer	Outgoing		
<b>IP 43 - Metal Door</b>					
4 way	8	2+2+2	4+4+4	DBHPI004DD	5345
6 way	8	2+2+2	6+6+6	DBHPI006DD	6385
8 way	8	2+2+2	8+8+8	DBHPI008DD	7590
12 way	8	2+2+2	12+12+12	DBHPI012DD	10375
16 way	8	2+2+2	16+16+16	DBHPI016DD	12450
<b>IP 54 - Metal Door</b>					
4 way	8	2+2+2	4+4+4	DBHPI00454	12535
6 way	8	2+2+2	6+6+6	DBHPI00654	14935
8 way	8	2+2+2	8+8+8	DBHPI00854	16495
12 way	8	2+2+2	12+12+12	DBHPI01254	22515
16 way	8	2+2+2	16+16+16	DBHPI01654	26775



Tier PPI DBs

IP 43 - Metal Door

Description	No. of Modules			Cat. Nos.	M.R.P. (₹) Per Unit
	Incomer	Sub-Incomer	Outgoing		
<b>IP 43 - Metal Door</b>					
6 way	8	2+2+2	6+6+6	DBTPI006DD	7210
8 way	8	2+2+2	8+8+8	DBTPI008DD	9045
10 way	8	2+2+2	10+10+10	DBTPI010DD	9485
12 way	8	2+2+2	12+12+12	DBTPI012DD	10320
16 way	8	2+2+2	16+16+16	DBTPI016DD	10865
12 way	MCCB*	2+2+2	12+12+12	DBTPL012DD	10750
<b>IP 54 - Metal Door</b>					
6 way	8	2+2+2	6+6+6	DBTPI00654	11850
8 way	8	2+2+2	8+8+8	DBTPI00854	14875
10 way	8	2+2+2	10+10+10	DBTPI01054	15605
12 way	8	2+2+2	12+12+12	DBTPI01254	16970
16 way	8	2+2+2	16+16+16	DBTPI01654	17870
12 way	MCCB*	2+2+2	12+12+12	DBTPL01254	17685

\* Suitable for 3 Pole & 4 Pole DU100H, DU100D, DN0-100D & DN0-100C MCCB as incomer

## TPN Phase Segregated DB [8537]

### Highlights

- IK 08-for single door DBs. IK 09-for double door DBs
- Available in CRCA sheet steel, RAL 9003, powder coated
- Ready to use DBs - Provided with 100A insulated phase bus-bars | neutral bar/s with shroud/s | earth bar/s | sticking saddles | cement spill protector | color-coded interconnecting wire set | cable ties | blanking plates and circuit identification labels
- With provision for 1. Modular Incomer - FP MCB/Isolator/RCCB/RCBO as incomer, DP RCCB/RCBO as sub-incomer and SP MCBs as outgoing  
2. MCCB Incomer - MCCB\* as incomer, DP RCCB/RCBO as sub-incomer and SP MCBs as outgoing



IP 30 - Single Door



IP 43 - Metal Door

With Modular Incomer

Description	No. of Modules			Cat. Nos.	M.R.P. (₹) Per Unit
	Incomer	Sub-Incomer	Outgoing		
<b>IP 30 - Single Door</b>					
4 way	8	4+4+4	4+4+4	DBPSG004SD	7565
6 way	8	4+4+4	6+6+6	DBPSG006SD	8255
8 way	8	4+4+4	8+8+8	DBPSG008SD	8845
12 way	8	4+4+4	12+12+12	DBPSG012SD	10180
<b>IP 43 - Metal Door</b>					
4 way	8	4+4+4	4+4+4	DBPSG004DD	8620
6 way	8	4+4+4	6+6+6	DBPSG006DD	9720
8 way	8	4+4+4	8+8+8	DBPSG008DD	10845
12 way	8	4+4+4	12+12+12	DBPSG012DD	13580
<b>IP 54 - Metal Door</b>					
4 way	8	4+4+4	4+4+4	DBPSG00454	14315
6 way	8	4+4+4	6+6+6	DBPSG00654	16120
8 way	8	4+4+4	8+8+8	DBPSG00854	18005
12 way	8	4+4+4	12+12+12	DBPSG01254	22975



IP 30 - Single Door



IP 43 - Metal Door

With MCCB Incomer

Description	No. of Modules			Cat. Nos.	M.R.P. (₹) Per Unit
	Incomer*	Sub-Incomer	Outgoing		
<b>IP 30 - Single Door</b>					
4 way	MCCB	4+4+4	4+4+4	DBPGL004SD	10895
6 way	MCCB	4+4+4	6+6+6	DBPGL006SD	12540
8 way	MCCB	4+4+4	8+8+8	DBPGL008SD	14405
12 way	MCCB	4+4+4	12+12+12	DBPGL012SD	16725
<b>IP 43 - Metal Door</b>					
4 way	MCCB	4+4+4	4+4+4	DBPGL004DD	12430
6 way	MCCB	4+4+4	6+6+6	DBPGL006DD	14220
8 way	MCCB	4+4+4	8+8+8	DBPGL008DD	16290
12 way	MCCB	4+4+4	12+12+12	DBPGL012DD	18545
<b>IP 54 - Metal Door</b>					
4 way	MCCB	4+4+4	4+4+4	DBPGL00454	20810
6 way	MCCB	4+4+4	6+6+6	DBPGL00654	23805
8 way	MCCB	4+4+4	8+8+8	DBPGL00854	27270
12 way	MCCB	4+4+4	12+12+12	DBPGL01254	31055

\* Suitable for 3 Pole & 4 Pole DU100H, DU100D, DN0-100D & DN0-100C MCCB as incomer

## TPN Phase Selector DB [8537]

### Highlights

- IK 08-for single door DBs, IK 09-for double door DBs
- Available in CRCA sheet steel, RAL 9003, powder coated
- Ready to use DBs - Provided with 3 nos. of 63A L&T rotary switches | 3 nos. of rocker switches for phase identification | 100A insulated phase bus-bars | neutral bar/s with shroud/s | earth bar/s | sticking saddles | color-coded interconnecting wire set | cable ties | blanking plates and circuit identification labels
- With provision for - FP MCB/Isolator/RCCB/RCBO as incomer and SP MCBs as outgoing



IP 30 - Single Door

IP 43 - Metal Door

Description	No. of Modules		Cat. Nos.	M.R.P. (₹) Per Unit
	Incomer	Outgoing		
<b>IP 30 - Single Door</b>				
4 way	8	4+4+4	DBPSR004SD	10475
6 way	8	6+6+6	DBPSR006SD	11135
8 way	8	8+8+8	DBPSR008SD	12340
10 way	8	10+10+10	DBPSR010SD	12800
12 way	8	12+12+12	DBPSR012SD	13545
<b>IP 43 - Metal Door</b>				
4 way	8	4+4+4	DBPSR004DD	11755
6 way	8	6+6+6	DBPSR006DD	11945
8 way	8	8+8+8	DBPSR008DD	12795
10 way	8	10+10+10	DBPSR010DD	13670
12 way	8	12+12+12	DBPSR012DD	14415
<b>IP 54 - Metal Door</b>				
4 way	8	4+4+4	DBPSR00454	15575
6 way	8	6+6+6	DBPSR00654	15825
8 way	8	8+8+8	DBPSR00854	16960
10 way	8	10+10+10	DBPSR01054	18115
12 way	8	12+12+12	DBPSR01254	19095

## Flexi/Row DB [8537]

### Highlights

- IK 08-for single door DBs, IK 09-for double door DBs
- Available in CRCA sheet steel, RAL 9003, powder coated
- Ready to use DBs - neutral bar/s with shroud/s | earth bar/s | sticking saddles | cement spill protector | cable ties | blanking plates and circuit identification labels
- With provision to mount modular devices as per requirement



IP 30 - Single Door

IP 43 - Metal Door

IP 43 - Glazed Door

Description	No. of Modules Per Row	Cat. Nos.	M.R.P. (₹) Per Unit
<b>IP 30 - Single Door</b>			
2 Row 28 Module	14	DBROW228SD	3445
3 Row 42 Module	14	DBROW342SD	4135
4 Row 56 Module	14	DBROW456SD	4735
4 Row 64 Module	16	DBROW464SD	5320
<b>IP 43 - Metal Door</b>			
2 Row 28 Module	14	DBROW228DD	3885
3 Row 42 Module	14	DBROW342DD	4665
4 Row 56 Module	14	DBROW456DD	5345
4 Row 64 Module	16	DBROW464DD	6000
<b>IP 43 - Glazed Door</b>			
2 Row 28 Module	14	DBROW228GD	4560
3 Row 42 Module	14	DBROW342GD	5590
4 Row 56 Module	14	DBROW456GD	6335
4 Row 64 Module	16	DBROW464GD	6950
<b>IP 54 - Metal Door</b>			
2 Row 28 Module	14	DBROW22854	7185
3 Row 42 Module	14	DBROW34254	8885
4 Row 56 Module	14	DBROW45654	9680
4 Row 64 Module	16	DBROW46454	10685

## DB Accessories

### Busbar - Fork Type [8538]

#### Highlights

- Conforms to IEC 61439-3
- Available in Single Pole, Double Pole, Three Pole and Four Pole versions
- Material : Copper



Description	Cat. Nos.	M.R.P. (₹) Per Unit	Std. Pack Qty.
SP 13 Mod	BSP13	265	5
SP 56 Mod	BSP56	995	5
DP 12 Mod	BDP12	435	5
TP 12 Mod	BTP12	465	5
FP 12 Mod	BFP12	975	5
End Caps for SP	ECP01	10	10
End Caps for DP/TP	ECP03	30	10
End Caps for FP	ECP04	40	10

### Blanking Plates [8538]

#### Highlights

- Available in One module and Half module



Description	Cat. Nos.	M.R.P. (₹) Per Unit	Std. Pack Qty.
One Module	BKP10	15	10
Half Module	BKP05	15	10

### Padlock [8301]

#### Highlights

- Version with standard lock and a common key



PDK02

Description	Cat. Nos.	M.R.P. (₹) Per Unit	Std. Pack Qty.
Lock and Key Kit	PDK02	435	5

## Vertical TPN DB with Modular Incomer [8537]

### Highlights

- IK 08-for single door DBs, IK 09-for double door DBs
- Available in CRCA sheet steel, RAL 9003, powder coated
- Ready to use DBs - Provided with insulated vertical phase bus-bars | neutral bar/s with shroud/s | earth bar/s | sticking saddles | cement spill protector | color-coded interconnecting wire set | cable ties | blanking plates and circuit identification labels
- With provision for FP MCB/Isolator/RCCB/RCBO as incomer and SP/TP MCBs as outgoing



IP 30 - Single Door      IP 43 - Metal Door      IP 43 - Glazed Door

Description	No. of Modules		Cat. Nos.	M.R.P. (₹) Per Unit
	Incomer	Outgoing		
<b>IP 30 - Single Door</b>				
4 way	8	4+4+4	DBVTM004SD	7555
6 way	8	6+6+6	DBVTM006SD	8270
8 way	8	8+8+8	DBVTM008SD	9225
12 way	8	12+12+12	DBVTM012SD	13320
16 way	8	16+16+16	DBVTM016SD	15405
<b>IP 43 - Metal Door</b>				
4 way	8	4+4+4	DBVTM004DD	8040
6 way	8	6+6+6	DBVTM006DD	9830
8 way	8	8+8+8	DBVTM008DD	10775
12 way	8	12+12+12	DBVTM012DD	14905
16 way	8	16+16+16	DBVTM016DD	17590
<b>IP 43 - Glazed Door</b>				
4 way	8	4+4+4	DBVTM004GD	10810
6 way	8	6+6+6	DBVTM006GD	11890
8 way	8	8+8+8	DBVTM008GD	13745
12 way	8	12+12+12	DBVTM012GD	18335
16 way	8	16+16+16	DBVTM016GD	19465
<b>IP 54 - Metal Door</b>				
4 way	8	4+4+4	DBVTM00454	16630
6 way	8	6+6+6	DBVTM00654	18505
8 way	8	8+8+8	DBVTM00854	19420
12 way	8	12+12+12	DBVTM01254	26655
16 way	8	16+16+16	DBVTM01654	28225

## Vertical TPN DB with MCCB Incomer [8537]

### Highlights

- IK 08-for single door DBs, IK 09-for double door DBs
- Available in CRCA sheet steel, RAL 9003, powder coated
- Ready to use DBs - Provided with insulated vertical phase bus-bars | neutral bar/s with shroud/s | earth bar/s | sticking saddles | cement spill protector | color-coded interconnecting wire set | cable ties | blanking plates and circuit identification labels
- With provision for 3 pole and 4 Pole MCCB\* as incomer and SP/TP MCBs as outgoing



IP 30 - Single Door      IP 43 - Metal Door      IP 43 - Glazed Door

Description	No. of Modules		Cat. Nos.	M.R.P. (₹) Per Unit
	Incomer*	Outgoing		
<b>IP 30 - Single Door</b>				
4 way	MCCB	4+4+4	DBVTL004SD	8755
6 way	MCCB	6+6+6	DBVTL006SD	9515
8 way	MCCB	8+8+8	DBVTL008SD	10360
12 way	MCCB	12+12+12	DBVTL012SD	15360
16 way	MCCB	16+16+16	DBVTL016SD	18170
<b>IP 43 - Metal Door</b>				
4 way	MCCB	4+4+4	DBVTL004DD	9610
6 way	MCCB	6+6+6	DBVTL006DD	11030
8 way	MCCB	8+8+8	DBVTL008DD	12080
12 way	MCCB	12+12+12	DBVTL012DD	16075
16 way	MCCB	16+16+16	DBVTL016DD	18920
<b>IP 43 - Glazed Door</b>				
4 way	MCCB	4+4+4	DBVTL004GD	11030
6 way	MCCB	6+6+6	DBVTL006GD	12495
8 way	MCCB	8+8+8	DBVTL008GD	14100
12 way	MCCB	12+12+12	DBVTL012GD	18795
16 way	MCCB	16+16+16	DBVTL016GD	20805
<b>IP 54 - Metal Door</b>				
4 way	MCCB	4+4+4	DBVTL00454	18955
6 way	MCCB	6+6+6	DBVTL00654	20325
8 way	MCCB	8+8+8	DBVTL00854	22785
12 way	MCCB	12+12+12	DBVTL01254	28755
16 way	MCCB	16+16+16	DBVTL01654	34410

\* Suitable for 3 Pole & 4 Pole DU100H, DU100D, DU125D, DU125H & DN0 MCCB as incomer

## Vertical TPN DB with MCCB Incomer [8537]

### Up to 250A MCCB Incomer



IP 30 - Single Door IP 43 - Metal Door IP 43 - Glazed Door

Description	No. of Modules		Cat. Nos.	M.R.P. (₹) Per Unit
	Incomer*	Outgoing		
<b>IP 30 - Single Door</b>				
4 way	MCCB	4+4+4	DBVTH004SD	10745
6 way	MCCB	6+6+6	DBVTH006SD	11275
8 way	MCCB	8+8+8	DBVTH008SD	12400
12 way	MCCB	12+12+12	DBVTH012SD	17515
16 way	MCCB	16+16+16	DBVTH016SD	21105
<b>IP 43 - Metal Door</b>				
4 way	MCCB	4+4+4	DBVTH004DD	12175
6 way	MCCB	6+6+6	DBVTH006DD	13830
8 way	MCCB	8+8+8	DBVTH008DD	15205
12 way	MCCB	12+12+12	DBVTH012DD	20355
16 way	MCCB	16+16+16	DBVTH016DD	24170
<b>IP 43 - Glazed Door</b>				
4 way	MCCB	4+4+4	DBVTH004GD	19995
6 way	MCCB	6+6+6	DBVTH006GD	22430
8 way	MCCB	8+8+8	DBVTH008GD	23330
12 way	MCCB	12+12+12	DBVTH012GD	24585
16 way	MCCB	16+16+16	DBVTH016GD	26455
<b>IP 54 - Metal Door</b>				
4 way	MCCB	4+4+4	DBVTH00454	26980
6 way	MCCB	6+6+6	DBVTH00654	29460
8 way	MCCB	8+8+8	DBVTH00854	30470
12 way	MCCB	12+12+12	DBVTH01254	35675
16 way	MCCB	16+16+16	DBVTH01654	37550

\* Suitable for 3 pole and 4 pole DU250, DU250C & DN1 MCCB as incomer

## Enclosure [8537]

### Highlights

- Suitable for Surface and Flush mounting
- Available in CRCA sheet steel, RAL9003, powder coated
- With provision to mount MCB/Isolator/RCCB/RCBO and other modular devices



IP 30 - Metal Door

Description	No. of Modules	Cat. Nos.	M.R.P. (₹) Per Unit
<b>IP 30 - Metal Door</b>			
2 way	2	DBENC002SD	515
3 way	3	DBENC003SD	515
4 way	4	DBENC004SD	515
6 way	6	DBENC006SD	775

## Plug & Socket DB [8537]

### Highlights

- Suitable for Surface and Flush mounting
- Available in CRCA sheet steel, RAL9003, powder coated
- Loose Metal Plugs & Sockets conforms to IS 8804; available in Single Phase & Three Phase



Metal Plug & Socket

Plastic Plug & Socket

Description	No. of Pins	No. of Modules	Cat. Nos.	M.R.P. (₹) Per Unit
<b>Metal Plug &amp; Sockets</b>				
10 A, 2 Pin + SC^	P + N	1	DBMPS110SD	1335
20 A, 2 Pin + SC^	P + N	1	DBMPS120SD	1435
20 A, 2 Pin + SC^	P + N	2	DBMPS220SD	1565
20 A, 3 Pin + SC^	3P	3	DBMPS320SD	2650
32 A, 3 Pin + SC^	3P	3	DBMPS332SD	3135
32 A, 3 Pin + SC^	3P	4	DBMPS432SD	3330
63 A, 5 Pin + SC^	3P+N+E	4	DBMPS463SD	11310
<b>Plastic Plug &amp; Sockets</b>				
16 A, 3 Pin	P+N+E	2	DBPPS316SD	2170
32 A, 3 Pin	P+N+E	4	DBPPS332SD	2345
32 A, 5 Pin	3P+N+E	8	DBPPS532SD	4265
63 A, 5 Pin	3P+N+E	8	DBPPS563SD	10845

## Metal Plug [8536]



Description	No. of Pins	Cat. Nos.	M.R.P. (₹) Per Unit
10 A, 2 Pin + SC^	P + N	MPS210P	140
20 A, 2 Pin + SC^	P + N	MPS220P	150
20 A, 3 Pin + SC^	3P	MPS320P	195
32 A, 3 Pin + SC^	3P	MPS332P	365

Note: Standard pack quantity - 20 nos.

## Metal Socket [8536]



Description	No. of Pins	Cat. Nos.	M.R.P. (₹) Per Unit
10 A, 2 Pin + SC^	P + N	MPS210S	145
20 A, 2 Pin + SC^	P + N	MPS220S	165
20 A, 3 Pin + SC^	3P	MPS320S	215
32 A, 3 Pin + SC^	3P	MPS332S	365

^SC-Scraping Earth

Note: Standard pack quantity - 20 nos.

## Cable End Boxes [8537]

### Highlights

- Available in CRCA sheet steel, RAL9003, powder coated
- Can be either at the top or bottom of the distribution board



Description	Cat. Nos.	M.R.P. (₹) Per Unit
<b>CEB for SPN DBs</b>		
CEB-SPN Double Door, 4 way	DBSPN004CB	580
CEB-SPN Double Door, 6 way	DBSPN006CB	615
CEB-SPN Double Door, 8 way	DBSPN008CB	685
CEB-SPN Double Door, 12 way	DBSPN012CB	765
CEB-SPN Double Door, 16 way	DBSPN016CB	1070
CEB-SPN Double Door, 18 way	DBSPN018CB	1130
<b>CEB for TPN DBs</b>		
CEB-TPN Double Door, 4 way	DBTPN004CB	970
CEB-TPN Double Door, 6 way	DBTPN006CB	1205
CEB-TPN Double Door, 8 way	DBTPN008CB	1900
CEB-TPN Double Door, 12 way	DBTPN012CB	2445
CEB-TPN Double Door, 16 way	DBTPN016CB	2470
CEB-TPE Double Door, 4 way	DBTPE004CB	910
CEB-TPE Double Door, 6 way	DBTPE006CB	1140
<b>CEB for Horizontal PPI DBs</b>		
CEB-Horz. PPI Double Door, 4 way	DBHPI004CB	1120
CEB-Horz. PPI Double Door, 6 way	DBHPI006CB	1270
CEB-Horz. PPI Double Door, 8 way	DBHPI008CB	1495
CEB-Horz. PPI Double Door, 12 way	DBHPI012CB	1675
CEB-Horz. PPI Double Door, 16 way	DBHPI016CB	1890
<b>CEB for Tier PPI DBs</b>		
CEB-Tier PPI Double Door, 6 way	DBTPI006CB	1060
CEB-Tier PPI Double Door, 8 way	DBTPI008CB	1105
CEB-Tier PPI Double Door, 10 way	DBTPI010CB	1340
CEB-Tier PPI Double Door, 12 way	DBTPI012CB	1640
CEB-Tier PPI Double Door, 16 way	DBTPI016CB	1745
CEB-Tier PPI Double Door, 12 way MCCB incomer	DBTPL012CB	1660

Description	Cat. Nos..	M.R.P. (₹) Per Unit
<b>CEB for VTPN DBs</b>		
CEB-VTPN Double Door, Modular Incomer	DBVTMXXCB	755
CEB-VTPN Double Door, MCCB Incomer	DBVTXXXCB	2710
<b>CEB for FLEXI DBs</b>		
CEB for Flexi DBs with 14 Modules per Row	DBROWX14CB	850
CEB for Flexi DBs with 16 Modules per Row	DBROWX16CB	985
<b>CEB for Phase Segregated DBs</b>		
CEB-PSG Double Door, 4 way	DBPSG004CB	1755
CEB-PSG Double Door, 6 way	DBPSG006CB	2090
CEB-PSG Double Door, 8 way	DBPSG008CB	2315
CEB-PSG Double Door, 12 way	DBPSG012CB	2575
<b>CEB for Phase Selector DBs</b>		
CEB-Phase Selector Double Door, 4 way	DBPSR004CB	840
CEB-Phase Selector Double Door, 6 way	DBPSR006CB	950
CEB-Phase Selector Double Door, 8 way	DBPSR008CB	1545
CEB-Phase Selector Double Door, 10 way	DBPSR010CB	1780
CEB-Phase Selector Double Door, 12 way	DBPSR012CB	1930



## DBs with provision for TV/Telephone splitters [8537]

### Highlights

- Distribution Boards equipped with provisions to mount TV / Telephone splitters
- Available in SPN & TPN DBs



DB Type	Description	No. of Modules		Cat. Nos.	M.R.P. (₹) Per Unit
		Incomer	Outgoing		
<b>IP 43 - Metal Door</b>					
SPN	6 way	2	4	DBSPN006DDTV	2975
	8 way	2	6	DBSPN008DDTV	3200
	12 way	2	10	DBSPN012DDTV	3960
	16 way	2	14	DBSPN016DDTV	4565
	18 way	2	16	DBSPN018DDTV	5610
TPN	4 way	8	4+4+4	DBTPN004DDTV	5630
	6 way	8	6+6+6	DBTPN006DDTV	6500
	8 way	8	8+8+8	DBTPN008DDTV	7545

*Specially Designed*

## Distribution Board suitable for Aluminum shuttering (Mivan) Construction

**New**



> To experience Scan or Click



### DBs suitable for Aluminium Shuttering (Mivan) Construction [8537]

#### SPN DBs

##### Highlights

- Available in CRCA sheet steel, RAL9003, powder coated
- Ready to use DBs - Provided with 100A insulated phase bus-bar | neutral bar/s with shroud/s | earth bar/s | sticking saddles | cement spill protector | color-coded interconnecting wire set | cable ties | blanking plates and circuit identification label
- With provision for DP MCB/Isolator/RCCB/RCBO as incomer and SP MCBs as outgoing

Description	No. of Modules		Cat. Nos.	M.R.P. (₹) Per Unit
	Incomer + Outgoing			
IP 43 - Metal Door				
4 way	2	2	LTSD04M	*
6 way	2	4	LTSD06M	*
8 way	2	6	LTSD08M	*
12 way	2	10	LTSD12M	*
16 way	2	14	LTSD16M	*

#### TPN DBs

##### Highlights

- Available in CRCA sheet steel, RAL 9003, powder coated
- Ready to use DBs - Provided with 100A insulated phase bus-bars | neutral bar/s with shroud/s | earth bar/s | sticking saddles | cement spill protector | color-coded interconnecting wire set | cable ties | blanking plates and circuit identification labels
- With provision for FP MCB/Isolator/RCCB/RCBO as incomer and SP MCBs as outgoing

Description	No. of Modules		Cat. Nos.	M.R.P. (₹) Per Unit
	Incomer + Outgoing			
IP 43 - Metal Door				
4 way	8	4+4+4	LTTD04M	*
6 way	8	6+6+6	LTTD06M	*
8 way	8	8+8+8	LTTD08M	*

\* For details, please contact L&T branch office



## Distribution Board (DB) Selection Guide

SPN	<ul style="list-style-type: none"> <li>- For single phase supply distribution</li> </ul>
TPN	<ul style="list-style-type: none"> <li>- For three phase supply distribution</li> </ul>
TPN - Horizontal PPI	<ul style="list-style-type: none"> <li>- For three phase supply distribution in Horizontal disposition</li> <li>- Isolation between phases is achieved with leakage protection device as sub-incomer and separate neutral bar for individual phases (PPI - Per Phase Isolation)</li> <li>- In case one of the circuits experiences earth leakage fault in a specific phase, sub-incomer of that phase trips leaving other phases operate normally</li> </ul>
TPN - Tier PPI	<ul style="list-style-type: none"> <li>- For three phase supply distribution in Tier/Vertical disposition</li> <li>- Isolation between phases is achieved with leakage protection device as sub-incomer and separate neutral bar for individual phases (PPI - Per Phase Isolation)</li> <li>- In case one of the circuits experiences earth leakage fault in a specific phase, sub-incomer of that phase trips leaving other phases operate normally</li> </ul>
VTPN Modular Incomer	<ul style="list-style-type: none"> <li>- For three phase supply distribution (Vertical TPN)</li> <li>- For sites with constraint on mounting DB of higher width</li> <li>- Higher rating (125A) of incomer and corresponding bus bar</li> <li>- Combination of single phase and three phase outgoing MCBs</li> <li>- DBs come with PAN assembly for ready installation of incomer and outgoing devices</li> </ul>
VTPN MCCB Incomer	<ul style="list-style-type: none"> <li>- For three phase supply distribution</li> <li>- For sites with constraint on mounting DB of higher width</li> <li>- Combination of single phase and three phase outgoing MCBs</li> <li>- For MCCB as incomer (with current rating up to 250A) with typically higher breaking capacity than that of an MCB</li> <li>- DBs come with PAN assembly for ready installation of incomer and outgoing devices</li> </ul>
TPN - Phase Segregated (7 Segment)	<ul style="list-style-type: none"> <li>- For three phase supply distribution</li> <li>- Isolation between phases is achieved with leakage protection device as sub-incomer and separate neutral bar for individual phases</li> <li>- Physical separation between outgoing phases, phase sub-incomer and main incomer</li> <li>- Owing to compartmental design, any of the sections can be individually opened</li> </ul>
TPN - Phase Selector	<ul style="list-style-type: none"> <li>- For three phase supply distribution</li> <li>- To maintain continuity of supply to a critical load by switching over to live phase temporarily</li> </ul>
Flexi / Row	<ul style="list-style-type: none"> <li>- Choice of either single phase or three phase supply distribution</li> <li>- Choice of number of modules for incoming and outgoing as per specific requirement</li> <li>- Choice of installing monitoring and control devices</li> </ul>
Enclosure	<ul style="list-style-type: none"> <li>- Enclosure for modular devices</li> </ul>
Plug & Socket	<ul style="list-style-type: none"> <li>- Providing protection to standalone single phase and three phase loads</li> </ul>

Distribution  
Transformer

Power  
Control  
Centre  
(PCC)

Main  
Distribution  
Board  
(MDB)



Final  
Distribution  
Board  
(FDB)

## Off-the-shelf Solution for Power Distribution

### Sub-Main Distribution Board **ENERSYS-S**

- Ready-to-use solution with MCCB as incomer and multiple MCCBs as outgoing devices
- Suitable for power distribution in commercial buildings, hotels, hospitals and educational establishments
- Incomer MCCB ratings – 250A, 400A, 630A
- Ingress Protection – IP43
- Short-time withstand current
  - 250A & 400A SMDB - 36 kA 1s
  - 630A SMDB - 50 kA 1s
- Metering and cabling extensions as add-on accessories
- Certified by ASTA and DEKRA as per IEC 61439-1 & 2

#### Customer Interaction Center (CIC)

BSNL / MTNL (toll free): 1800 233 5858 Reliance (toll free): 1800 200 5858  
Tel: 022 6774 5858 Email: cic@Lntebg.com Web: www.Lntebg.com

## Dimension Details SPN DB

### IP 30 single door

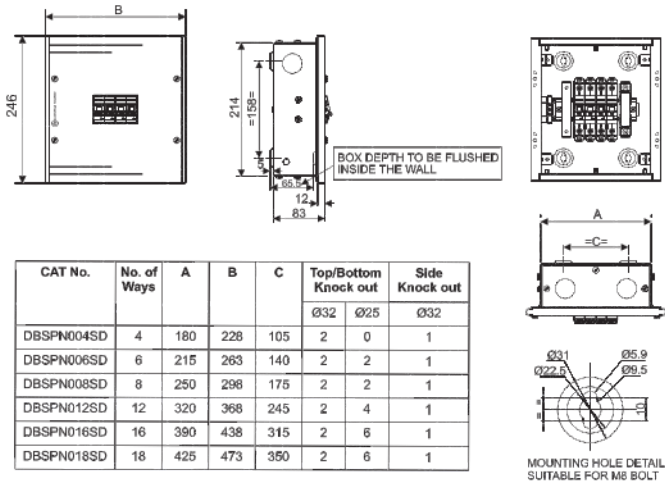

### IP 43 glazed door

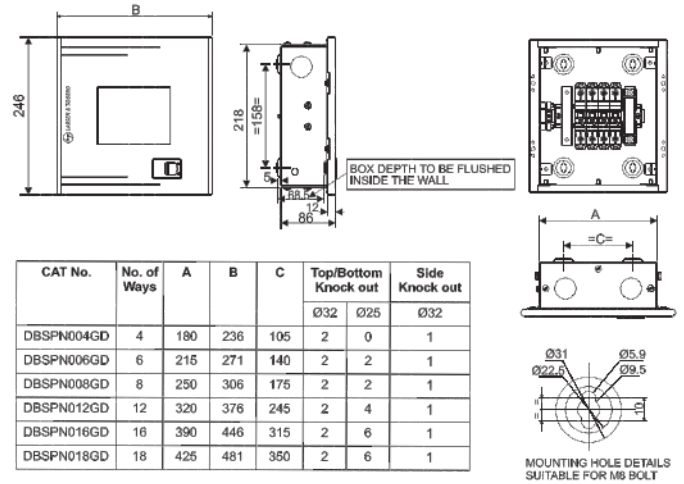

### IP 43 metal door

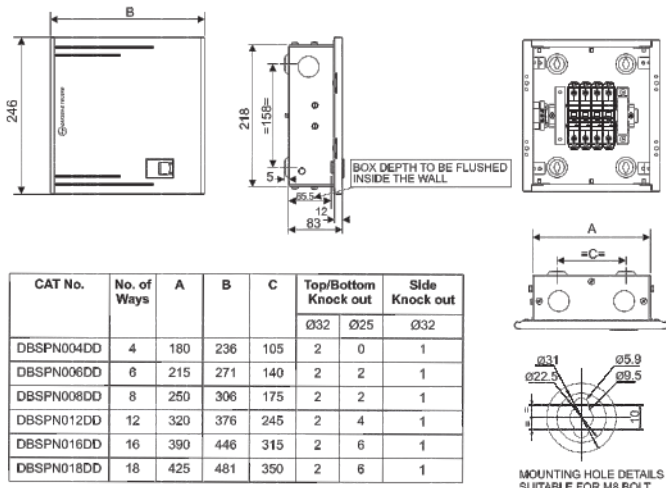

### IP 54 metal door

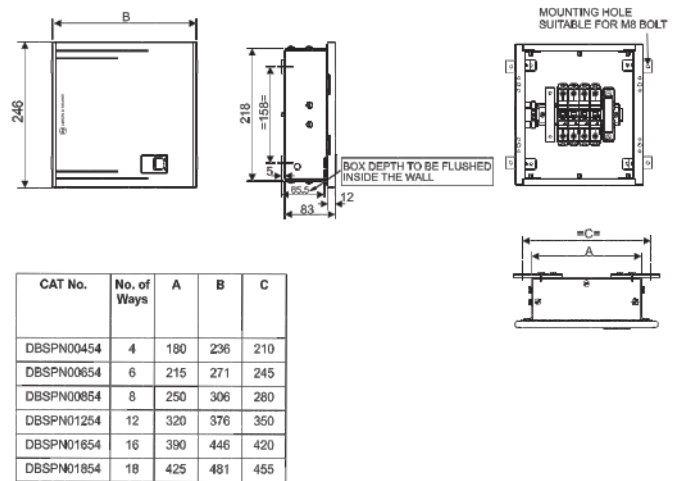

## Dimension Details TPN DB

### IP 30 single door

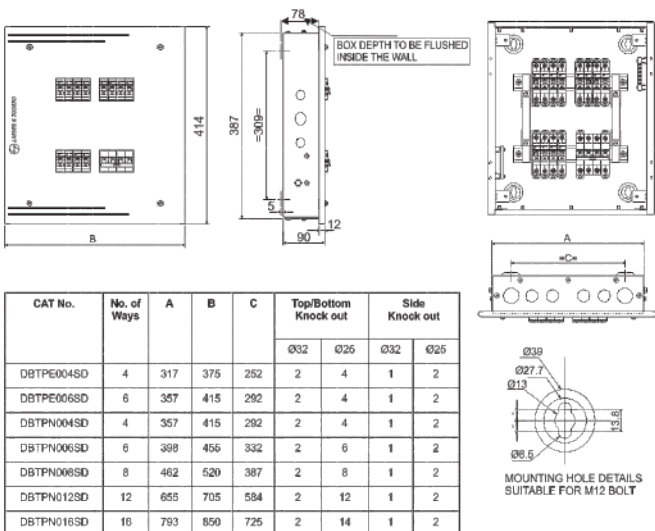

### IP 43 metal door

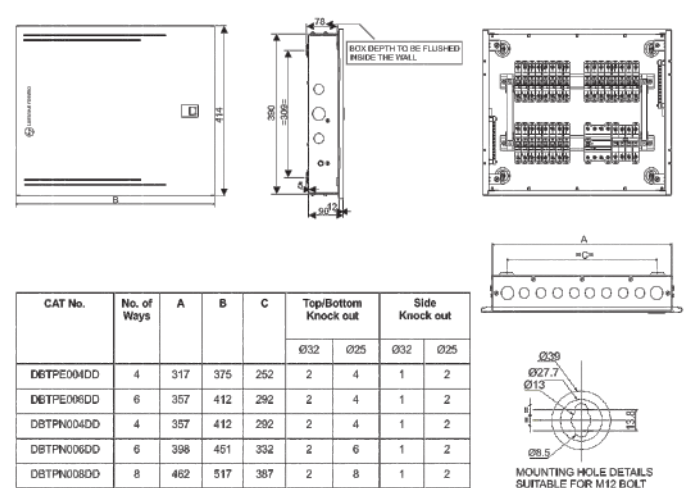

UNLESS OTHERWISE SPECIFIED DIMENSIONS ARE IN mm  
TOLERANCE ON DIMENSIONS = ±2 mm

# Dimension Details TPN DB

## IP 43 metal door

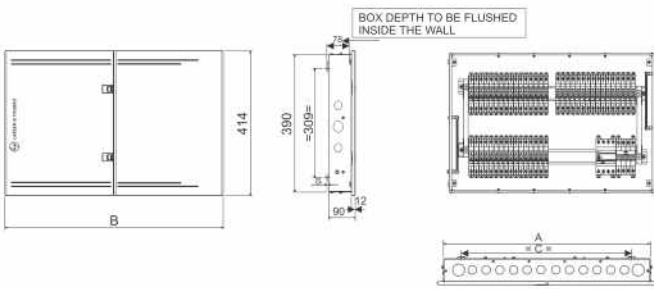

CAT No.	No. of Ways	A	B	C	Top/Bottom Knock out		Side Knock out	
					Ø32	Ø25	Ø32	Ø25
DBTPN012DD	12	655	712	584	2	12	1	2
DBTPN016DD	16	793	850	725	2	14	1	2



## IP 43 glazed door

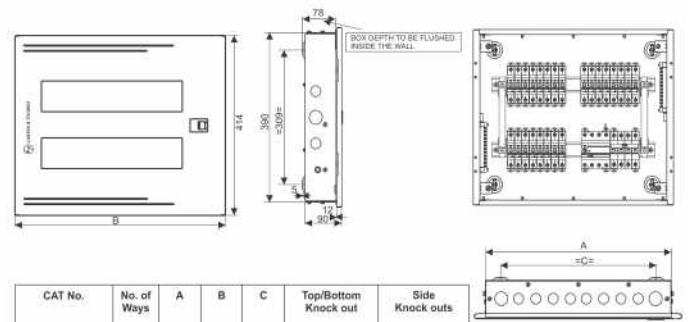

CAT No.	No. of Ways	A	B	C	Top/Bottom Knock out		Side Knock out	
					Ø32	Ø25	Ø32	Ø25
DBTPE004GD	4	317	375	252	2	4	1	2
DBTPE006GD	6	357	412	292	2	4	1	2
DBTPN004GD	4	357	412	292	2	4	1	2
DBTPN006GD	6	398	451	332	2	8	1	2
DBTPN008GD	8	462	517	387	2	8	1	2

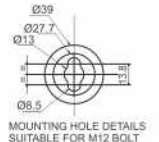

## IP 54 metal door

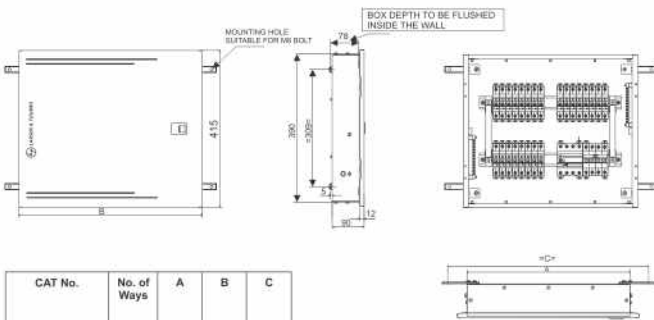

CAT No.	No. of Ways	A	B	C
DBTPE00454	4	317	375	427
DBTPE00654	6	357	412	467
DBTPN00454	4	357	412	467
DBTPN00654	6	398	451	507
DBTPN00854	8	462	517	571

## IP 43 glazed door

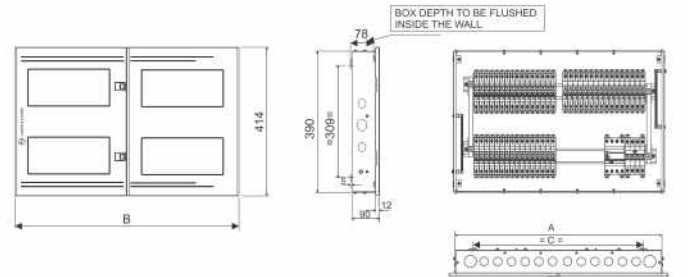

CAT No.	No. of Ways	A	B	C	Top/Bottom Knock out		Side Knock out	
					Ø32	Ø25	Ø32	Ø25
DBTPN012GD	12	655	712	584	2	12	1	2
DBTPN016GD	16	793	850	725	2	14	1	2



## IP 54 metal door

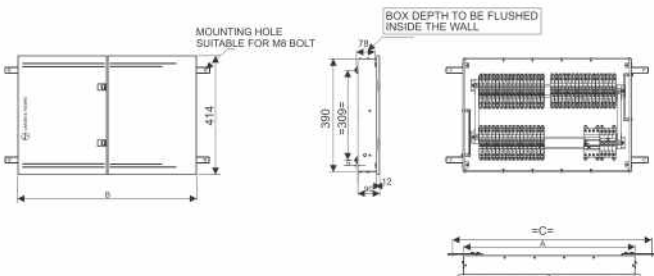

CAT No.	No. of Ways	A	B	C
DBTPN01254	12	655	712	764
DBTPN01654	16	793	850	906

UNLESS OTHERWISE SPECIFIED DIMENSIONS ARE IN mm  
TOLERANCE ON DIMENSIONS = ±2 mm

## Dimension Details Horizontal PPI DB

### IP 43 metal door

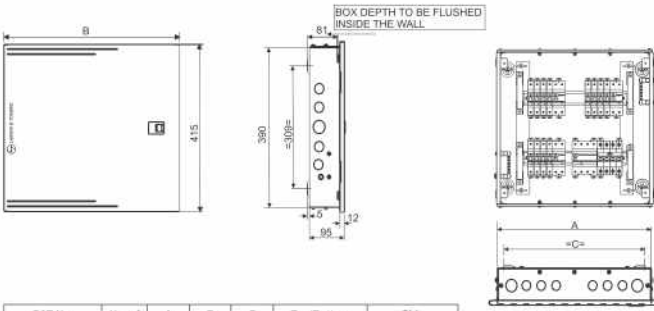

CAT No.	No. of Ways	A	B	C	Top/Bottom Knock out		Side Knock out	
					Ø32	Ø25	Ø32	Ø25
DBHP1004DD	4	444	489	383	2	6	1	4
DBHP1006DD	6	479	525	418	2	8	1	4
DBHP1008DD	8	549	595	487	2	9	1	4



### IP 54 metal door

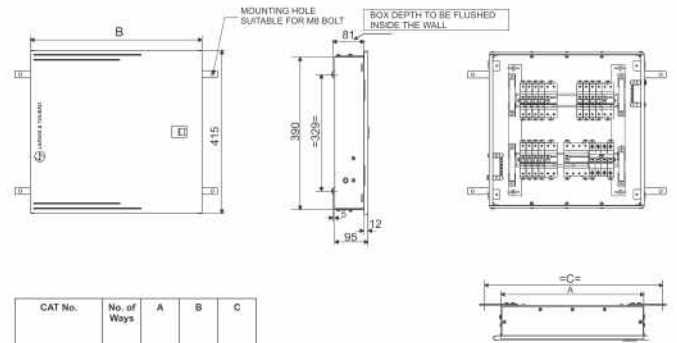

CAT No.	No. of Ways	A	B	C
DBHP100454	4	444	489	564
DBHP100654	6	479	525	589
DBHP100854	8	549	595	659

### IP 43 metal door

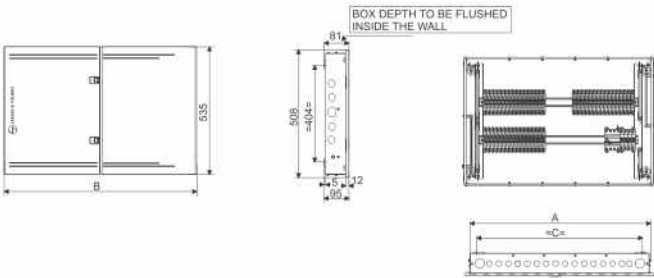

CAT No.	No. of Ways	A	B	C	Top/Bottom Knock out		Side Knock out	
					Ø32	Ø25	Ø32	Ø25
DBHP1012DD	12	723	771	695	2	14	1	4
DBHP1016DD	16	868	916	800	2	18	1	4



### IP 54 metal door

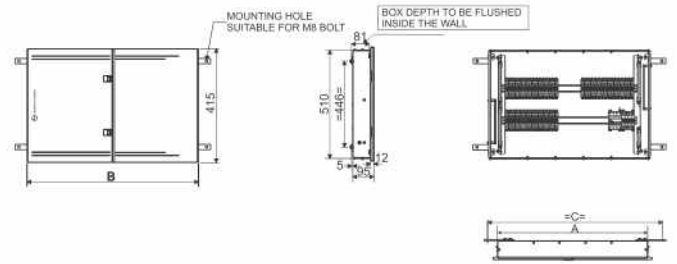

CAT No.	No. of Ways	A	B	C
DBHP101254	12	723	771	832
DBHP101654	16	868	916	977

## Dimension Details Tier PPI DB

### IP 43 metal door

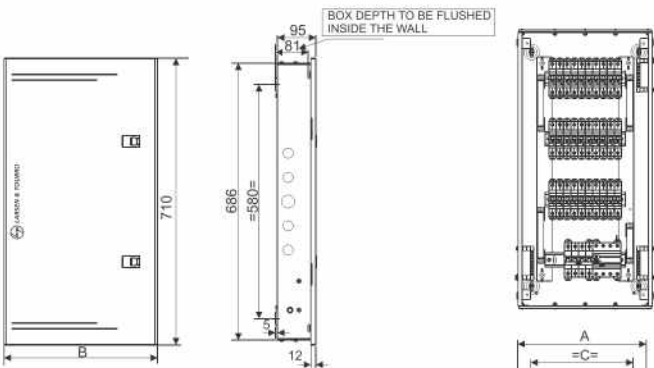

CAT No.	No. of Ways	A	B	C	Top/Bottom Knock out		Side Knock out	
					Ø32	Ø25	Ø32	Ø25
DBTPI006DD	6	283	330	215	2	2	1	4
DBTPI008DD	8	333	380	265	2	4	1	4
DBTPI010DD	10	383	430	315	2	6	1	4
DBTPI012DD	12	433	480	365	2	6	1	4
DBTPI016DD	16	533	570	465	2	8	1	4



### IP 43 metal door- MCCB incomer

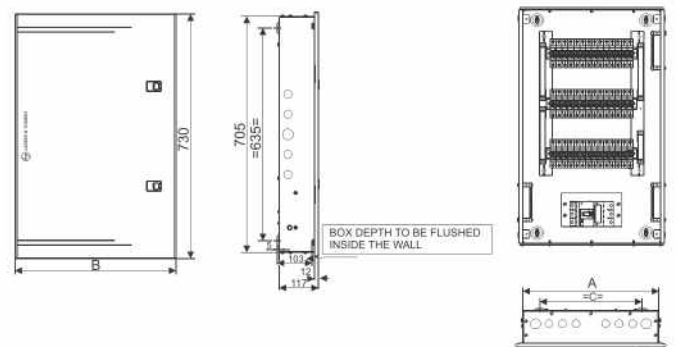

CAT No.	No. of Ways	A	B	C	Top/Bottom Knock out		Side Knock out	
					Ø32	Ø25	Ø32	Ø25
DBTPL012DD	12	433	480	325	2	6	1	4

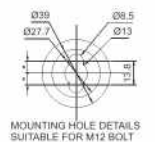

UNLESS OTHERWISE SPECIFIED DIMENSIONS ARE IN mm  
TOLERANCE ON DIMENSIONS = ±2 mm

## Dimension Details Tier PPI DB

### IP 54 metal door

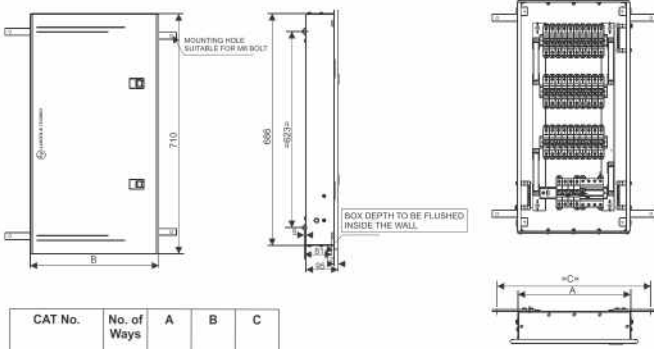

CAT No.	No. of Ways	A	B	C
DBTPI00654	6	283	330	392
DBTPI00854	8	333	380	442
DBTPI01054	10	383	430	492
DBTPI01254	12	433	480	542
DBTPI01654	16	533	570	642

### IP 54 metal door - MCCB Incomer

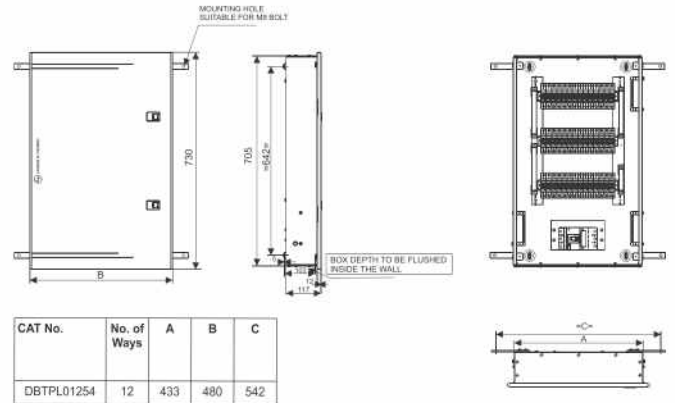

CAT No.	No. of Ways	A	B	C
DBTPL01254	12	433	480	542

## Dimension Details VTPN DB-MCB Incomer

### IP 30 metal door

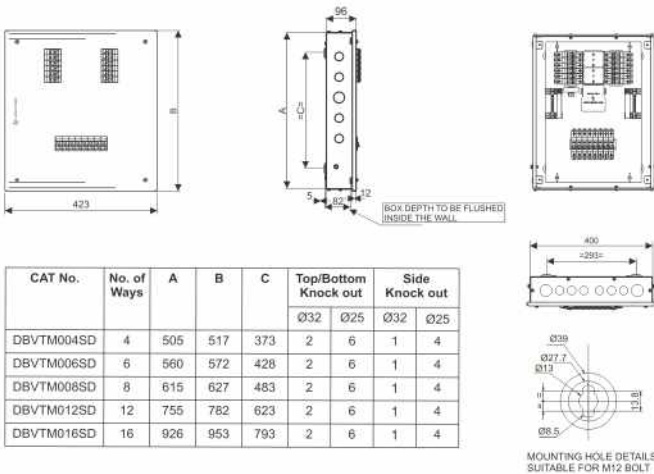

CAT No.	No. of Ways	A	B	C	Top/Bottom Knock out		Side Knock out	
					Ø32	Ø25	Ø32	Ø25
DBVTM004SD	4	505	517	373	2	6	1	4
DBVTM006SD	6	560	572	428	2	6	1	4
DBVTM008SD	8	615	627	483	2	6	1	4
DBVTM012SD	12	755	782	623	2	6	1	4
DBVTM016SD	16	926	953	793	2	6	1	4

### IP 43 glazed door

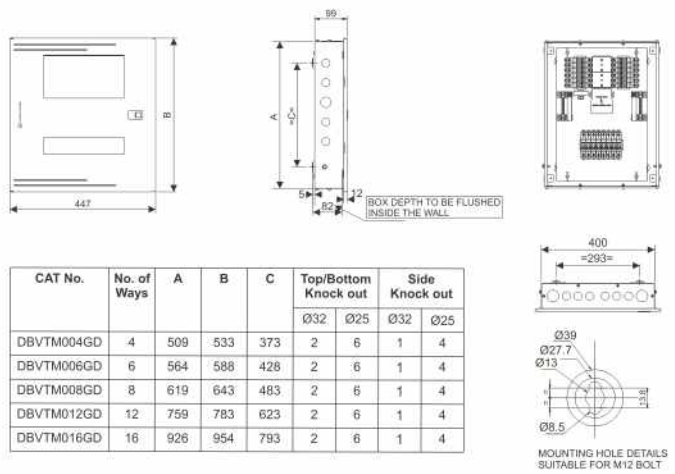

CAT No.	No. of Ways	A	B	C	Top/Bottom Knock out		Side Knock out	
					Ø32	Ø25	Ø32	Ø25
DBVTM004GD	4	509	533	373	2	6	1	4
DBVTM006GD	6	564	588	428	2	6	1	4
DBVTM008GD	8	619	643	483	2	6	1	4
DBVTM012GD	12	759	783	623	2	6	1	4
DBVTM016GD	16	926	954	793	2	6	1	4

### IP 43 metal door

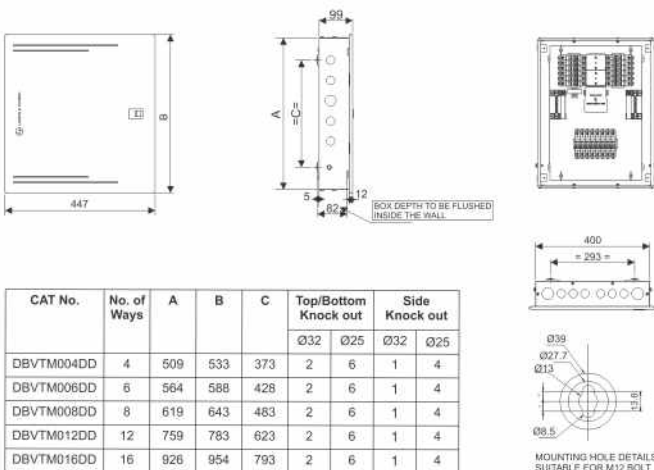

CAT No.	No. of Ways	A	B	C	Top/Bottom Knock out		Side Knock out	
					Ø32	Ø25	Ø32	Ø25
DBVTM004DD	4	509	533	373	2	6	1	4
DBVTM006DD	6	564	588	428	2	6	1	4
DBVTM008DD	8	619	643	483	2	6	1	4
DBVTM012DD	12	759	783	623	2	6	1	4
DBVTM016DD	16	926	954	793	2	6	1	4

### IP 54 metal door

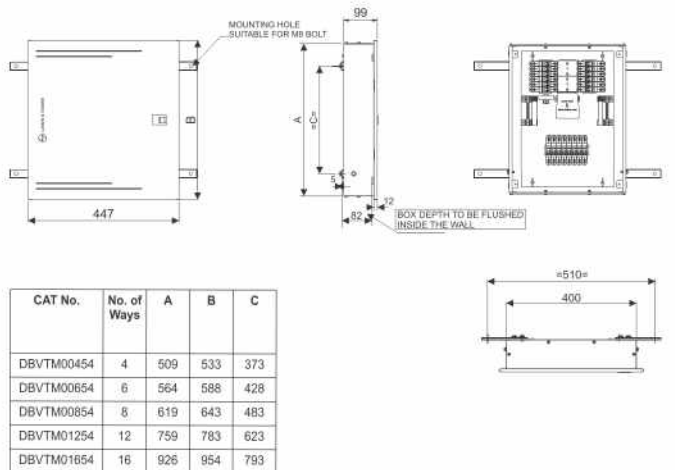

CAT No.	No. of Ways	A	B	C
DBVTM00454	4	509	533	373
DBVTM00654	6	564	588	428
DBVTM00854	8	619	643	483
DBVTM01254	12	759	783	623
DBVTM01654	16	926	954	793

UNLESS OTHERWISE SPECIFIED DIMENSIONS ARE IN mm  
TOLERANCE ON DIMENSIONS = ±2 mm

## Dimension Details VTPN DB-125A MCCB Incomer

### IP 30 metal door

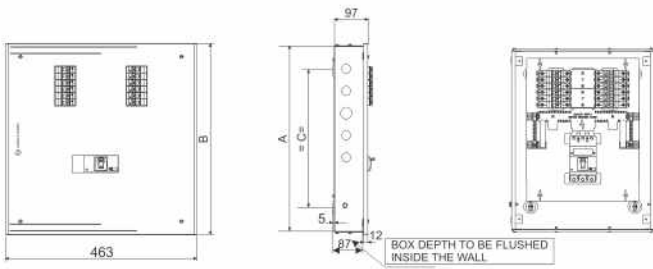

CAT No.	No. of Ways	A	B	C	Top/Bottom Knock out		Side Knock out	
					Ø32	Ø25	Ø32	Ø25
DBVTL004SD	4	505	518	373	2	6	1	4
DBVTL006SD	6	560	573	428	2	6	1	4
DBVTL008SD	8	615	628	483	2	6	1	4
DBVTL012SD	12	725	738	593	2	6	1	4
DBVTL016SD	16	851	863	718	2	6	1	4

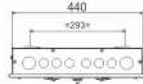

MOUNTING HOLE DETAILS SUITABLE FOR M12 BOLT

### IP 43 glazed door

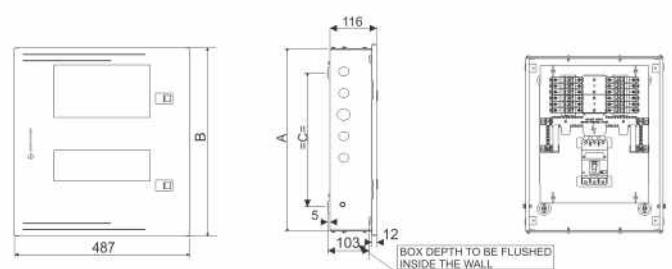

CAT No.	No. of Ways	A	B	C	Top/Bottom Knock out		Side Knock out	
					Ø32	Ø25	Ø32	Ø25
DBVTL004GD	4	509	533	373	2	6	1	4
DBVTL006GD	6	564	588	428	2	6	1	4
DBVTL008GD	8	619	643	483	2	6	1	4
DBVTL012GD	12	729	753	593	2	6	1	4
DBVTL016GD	16	851	879	718	2	6	1	4

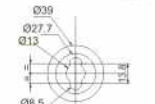
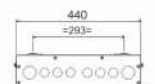

MOUNTING HOLE DETAILS SUITABLE FOR M12 BOLT

### IP 43 metal door

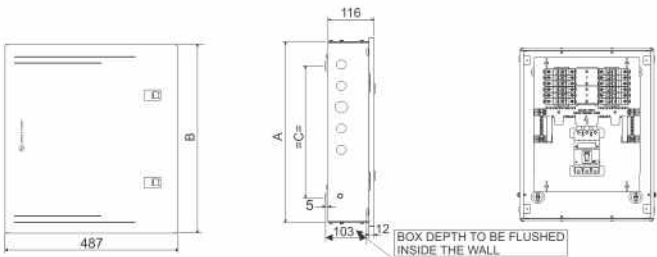

CAT No.	No. of Ways	A	B	C	Top/Bottom Knock out		Side Knock out	
					Ø32	Ø25	Ø32	Ø25
DBVTL004DD	4	509	533	373	2	6	1	4
DBVTL006DD	6	564	588	428	2	6	1	4
DBVTL008DD	8	619	643	483	2	6	1	4
DBVTL012DD	12	729	753	593	2	6	1	4
DBVTL016DD	16	851	879	718	2	6	1	4

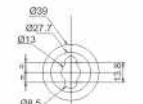
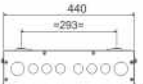

MOUNTING HOLE DETAILS SUITABLE FOR M12 BOLT

### IP 54 metal door

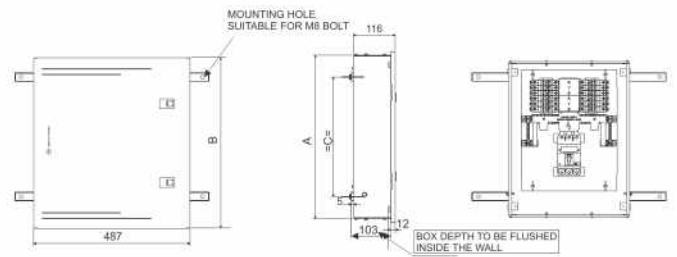

CAT No.	No. of Ways	A	B	C
DBVTL00454	4	509	533	380
DBVTL00654	6	564	588	435
DBVTL00854	8	619	643	490
DBVTL01254	12	729	753	600
DBVTL01654	16	851	879	725

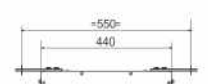

## Dimension Details VTPN DB-250A MCCB Incomer

### IP 30 metal door

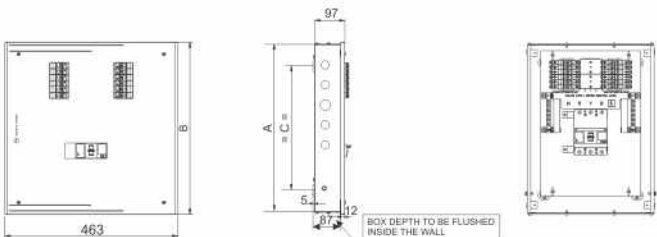

CAT No.	No. of Ways	A	B	C	Top/Bottom Knock out		Side Knock out	
					Ø32	Ø25	Ø32	Ø25
DBVTH004SD	4	615	628	483	2	6	1	4
DBVTH006SD	6	670	683	538	2	6	1	4
DBVTH008SD	8	725	738	593	2	6	1	4
DBVTH012SD	12	851	863	718	2	6	1	4
DBVTH016SD	16	1016	1028	883	2	6	1	4

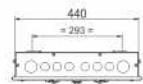

MOUNTING HOLE DETAILS SUITABLE FOR M12 BOLT

### IP 43 glazed door

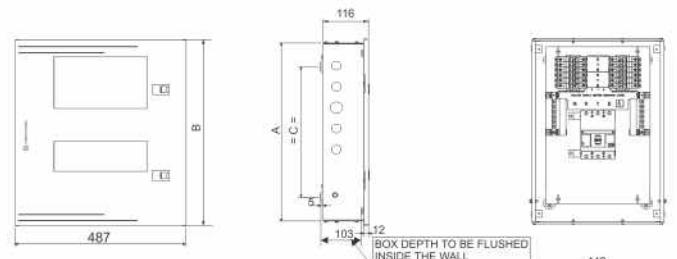

CAT No.	No. of Ways	A	B	C	Top/Bottom Knock out		Side Knock out	
					Ø32	Ø25	Ø32	Ø25
DBVTH004GD	4	615	643	483	2	6	1	4
DBVTH006GD	6	670	698	538	2	6	1	4
DBVTH008GD	8	725	753	593	2	6	1	4
DBVTH012GD	12	851	879	718	2	6	1	4
DBVTH016GD	16	1016	1044	883	2	6	1	4

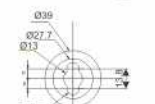
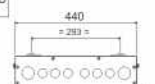

MOUNTING HOLE DETAILS SUITABLE FOR M12 BOLT

UNLESS OTHERWISE SPECIFIED DIMENSIONS ARE IN mm  
TOLERANCE ON DIMENSIONS = ±2 mm

# Dimension Details VTPN DB-250A MCCB Incomer

## IP 43 metal door

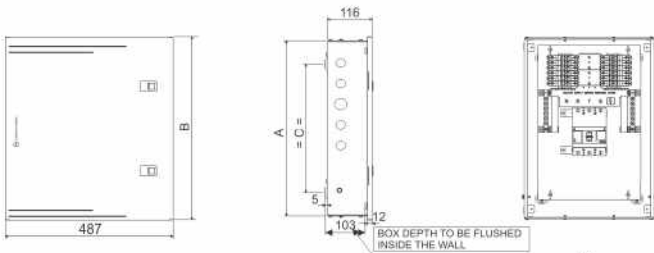

CAT No.	No. of Ways	A	B	C	Top/Bottom Knock out		Side Knock out	
					Ø32	Ø25	Ø32	Ø25
DBVTH004DD	4	615	643	483	2	6	1	4
DBVTH006DD	6	670	698	538	2	6	1	4
DBVTH008DD	8	725	753	593	2	6	1	4
DBVTH012DD	12	851	879	718	2	6	1	4
DBVTH016DD	16	1016	1044	883	2	6	1	4

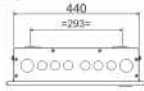

## IP 54 metal door

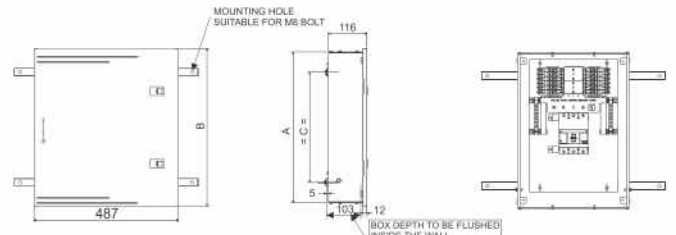

CAT No.	No. of Ways	A	B	C
DBVTH00454	4	615	643	490
DBVTH00654	6	670	698	545
DBVTH00854	8	725	753	600
DBVTH01254	12	851	879	725
DBVTH01654	16	1016	1044	890

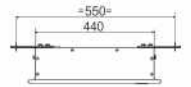

# Dimension Details Phase Selector DB

## IP 30 metal door

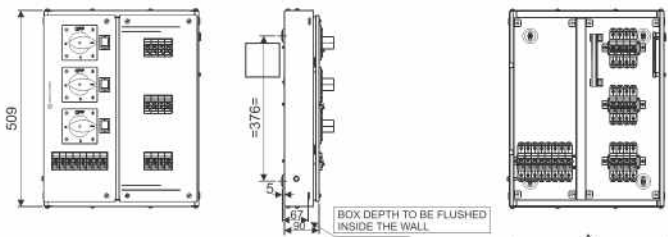

CAT No.	No. of Ways	A	B	Top/Bottom Knock out	
				Ø32	Ø25
DBPSR004SD	4	400	293	2	6
DBPSR006SD	6	435	328	2	6
DBPSR008SD	8	470	363	2	8
DBPSR010SD	10	505	398	2	8
DBPSR012SD	12	540	433	2	10

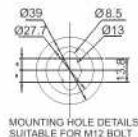
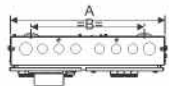

## IP 54 metal door

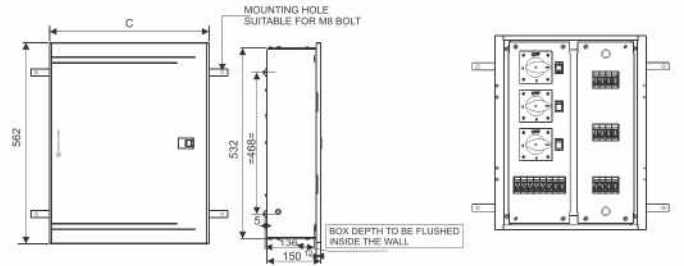

CAT No.	No. of Ways	A	B	C
DBPSR00454	4	400	510	445
DBPSR00654	6	435	545	480
DBPSR00854	8	470	580	515
DBPSR01054	10	505	615	550
DBPSR01254	12	540	650	585

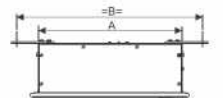

## IP 43 metal door

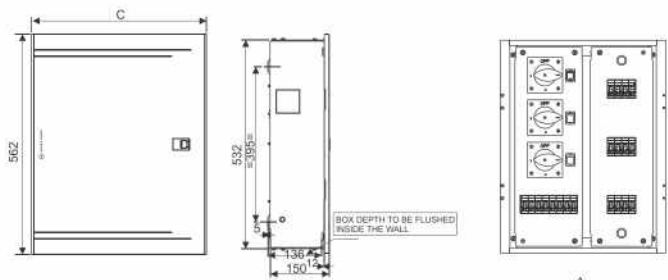

CAT No.	No. of Ways	A	B	C	Top/Bottom Knock out	
					Ø32	Ø25
DBPSR004DD	4	400	294	445	2	6
DBPSR006DD	6	435	329	480	2	6
DBPSR008DD	8	470	364	515	2	8
DBPSR010DD	10	505	399	550	2	8
DBPSR012DD	12	540	434	585	2	10

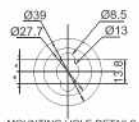
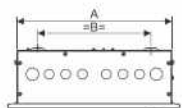

UNLESS OTHERWISE SPECIFIED DIMENSIONS ARE IN mm  
TOLERANCE ON DIMENSIONS = ±2 mm



## Dimension Details Phase Segregated DB-MCB Incomer

### IP 30 metal door

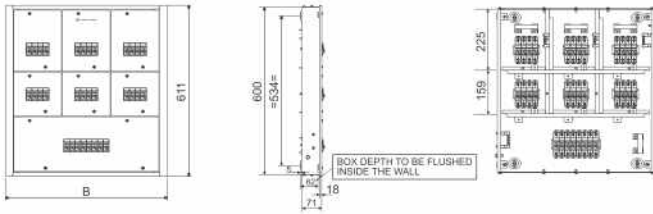

CAT No.	No. of Ways	A	B	C	Top/Bottom Knock out	
					Ø32	Ø25
DBPSG004SD	4	491	513	384	2	8
DBPSG006SD	6	596	618	489	2	10
DBPSG008SD	8	701	723	594	2	12
DBPSG012SD	12	911	933	804	2	18

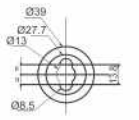
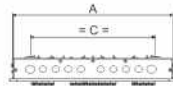

MOUNTING HOLE DETAILS SUITABLE FOR M12 BOLT

## Dimension Details Phase Segregated DB-MCCB Incomer

### IP 30 metal door

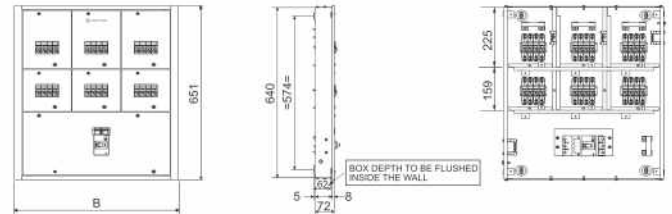

CAT No.	No. of Ways	A	B	C	Top/Bottom Knock out	
					Ø32	Ø25
DBPGL004SD	4	491	513	384	2	8
DBPGL006SD	6	596	618	489	2	10
DBPGL008SD	8	701	723	594	2	12
DBPGL012SD	12	911	933	804	2	18

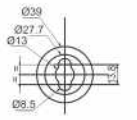
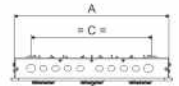

MOUNTING HOLE DETAILS SUITABLE FOR M12 BOLT

### IP 43 metal door

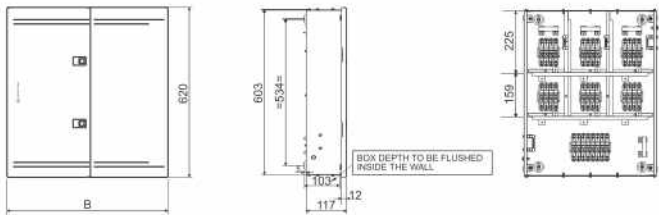

CAT No.	No. of Ways	A	B	C	Top/Bottom Knock out	
					Ø32	Ø25
DBPSG004DD	4	491	540	384	2	8
DBPSG006DD	6	596	646	489	2	10
DBPSG008DD	8	701	751	594	2	12
DBPSG012DD	12	911	961	804	2	18

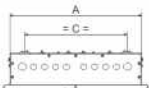

MOUNTING HOLE DETAILS SUITABLE FOR M12 BOLT

### IP 43 metal door



CAT No.	No. of Ways	A	B	C	Top/Bottom Knock out	
					Ø32	Ø25
DBPGL004DD	4	491	541	384	2	8
DBPGL006DD	6	596	646	489	2	10
DBPGL008DD	8	701	751	594	2	12
DBPGL012DD	12	911	961	804	2	18

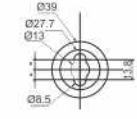
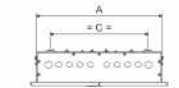

MOUNTING HOLE DETAILS SUITABLE FOR M12 BOLT

### IP 54 metal door

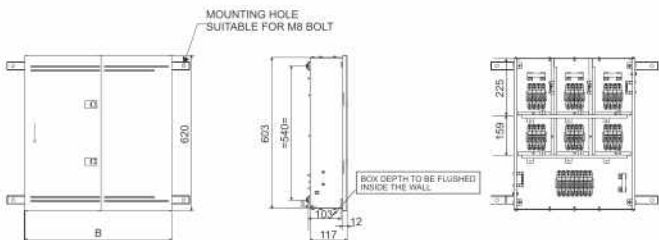

CAT No.	No. of Ways	A	B	C
DBPSG00654	6	596	646	706
DBPSG00854	8	701	751	811
DBPSG01254	12	911	961	1021

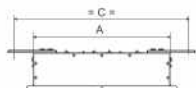

### IP 54 metal door

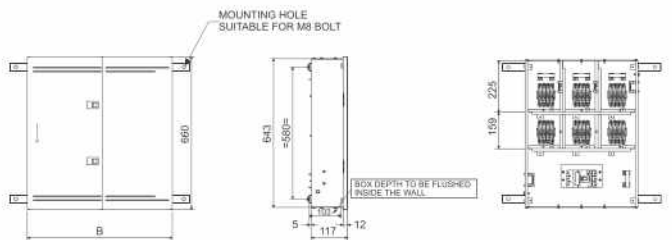

CAT No.	No. of Ways	A	B	C
DBPGL00654	6	596	646	706
DBPGL00854	8	701	751	811
DBPGL01254	12	911	961	1021

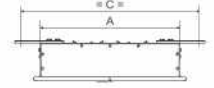

UNLESS OTHERWISE SPECIFIED DIMENSIONS ARE IN mm  
TOLERANCE ON DIMENSIONS = ±2 mm

## Dimension Details Flexi / Row DB

### IP 30 metal door

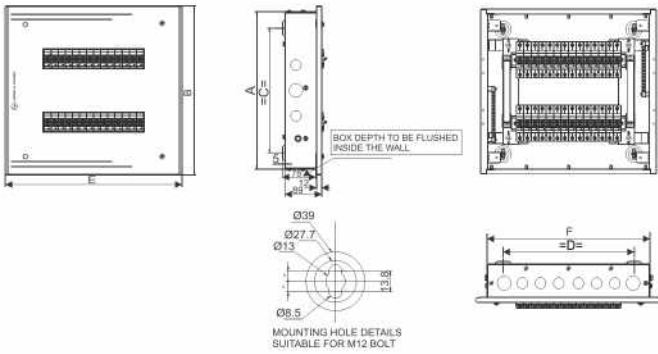

CAT No.	No. of Rows	No. of Mods/ Row	A	B	C	D	E	F	Top/Bottom Knock out		Side Knock out	
									Ø32	Ø25	Ø32	Ø25
DBROW228SD	2	14	372	400	295	310	440	385	2	6	1	2
DBROW342SD	3	14	552	580	475	310	440	385	2	6	1	4
DBROW456SD	4	14	682	710	605	310	440	385	2	6	1	4
DBROW464SD	4	16	682	710	605	350	480	425	2	6	1	4

### IP 43 glazed door

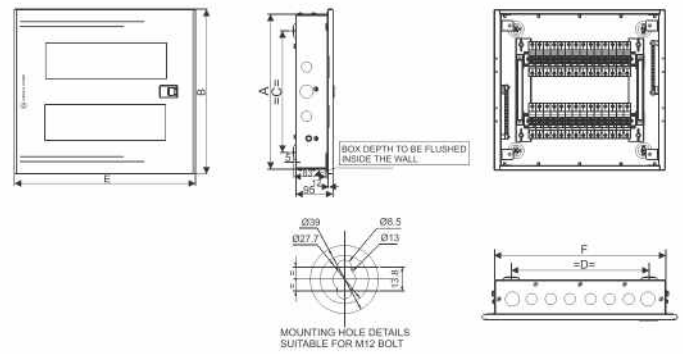

CAT No.	No. of Rows	No. of Mods/ Row	A	B	C	D	E	F	Top/Bottom Knock out		Side Knock out	
									Ø32	Ø25	Ø32	Ø25
DBROW228GD	2	14	376	400	295	310	440	385	2	6	1	2
DBROW342GD	3	14	556	580	475	310	440	385	2	6	1	4
DBROW456GD	4	14	686	710	605	310	440	385	2	6	1	4
DBROW464GD	4	16	686	710	605	350	480	425	2	6	1	4

### IP 43 metal door

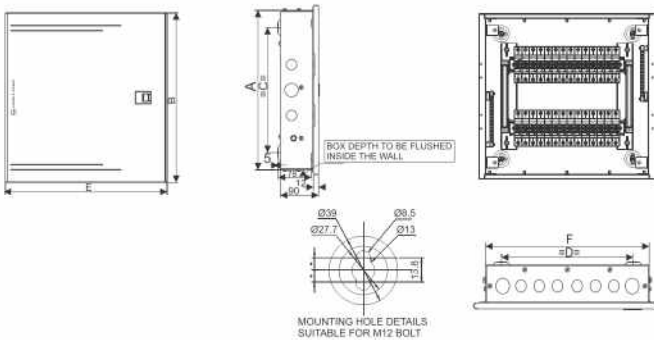

CAT No.	No. of Rows	No. of Mods/ Row	A	B	C	D	E	F	Top/Bottom Knock out		Side Knock out	
									Ø32	Ø25	Ø32	Ø25
DBROW228DD	2	14	376	400	295	310	440	385	2	6	1	2
DBROW342DD	3	14	556	580	475	310	440	385	2	6	1	4
DBROW456DD	4	14	686	710	605	310	440	385	2	6	1	4
DBROW464DD	4	16	686	710	605	350	480	425	2	6	1	4

### IP 54 metal door

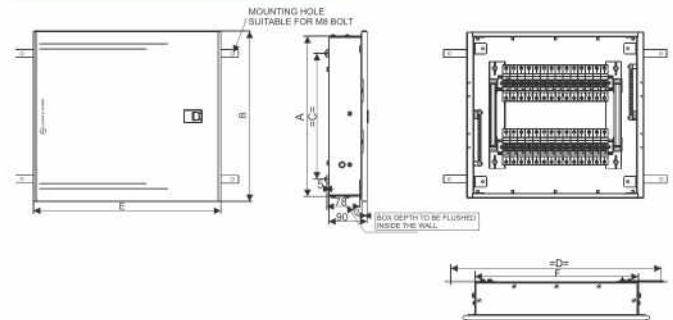

CAT No.	No. of Rows	No. of Mods/ Row	A	B	C	D	E	F
DBROW22854	2	14	376	400	295	494	440	385
DBROW34254	3	14	556	580	493	494	440	385
DBROW45654	4	14	686	710	623	494	440	385
DBROW46454	4	16	686	710	623	534	480	425

## Dimension Details Metal Plug & Socket DB

### Metal Plug & Socket DB

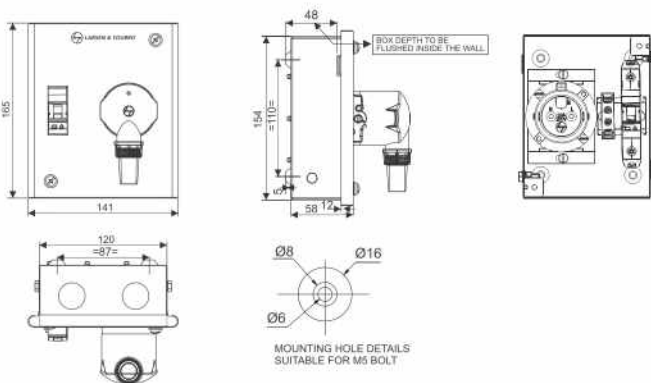

CAT No.	Description	Top/Bottom Knock out
		Ø25
DBMPS110SD	10A, 2Pin+SC - 1MOD	2
DBMPS120SD	20A, 2Pin+SC - 1MOD	2
DBMPS220SD	20A, 2Pin+SC - 2MOD	2

SC - Scraping Earth

### Metal Plug & Socket DB

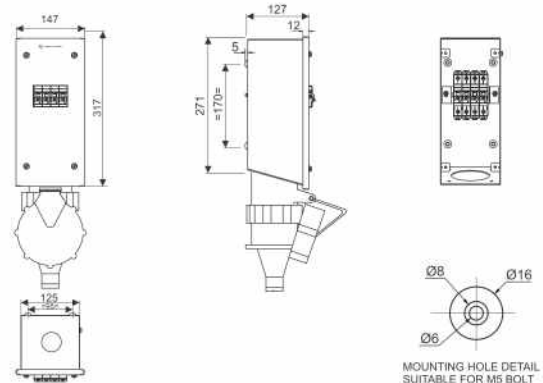

CAT No.	Description	Top/Bottom Knock out
		Ø25
DBMPS463SD	63A, 5Pin+SC - 4MOD	1

SC - Scraping Earth

UNLESS OTHERWISE SPECIFIED DIMENSIONS ARE IN mm  
TOLERANCE ON DIMENSIONS = ±2 mm

# Dimension Details Metal Plug & Socket DB

## Metal Plug & Socket DB

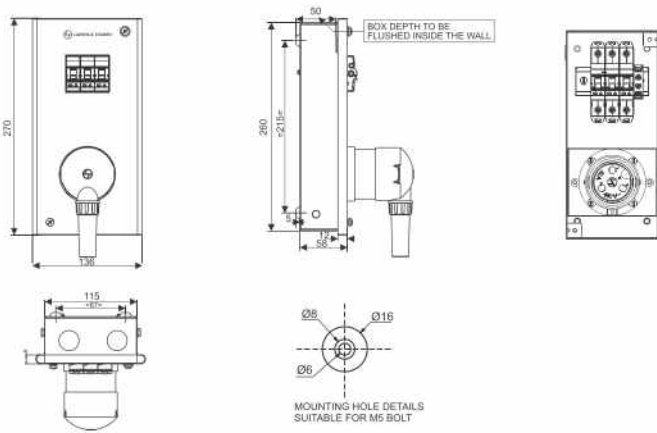

CAT No.	Description	Top/Bottom Knock out
		Ø25
DBMPS320SD	20A, 3Pin+SC - 3MOD	2
DBMPS332SD	32A, 3Pin+SC - 3MOD	2
DBMPS432SD	32A, 3Pin+SC - 4MOD	2

SC - Scraping Earth

# Dimension Details Plastic Plug & Socket DB

## Plastic Plug & Socket DB

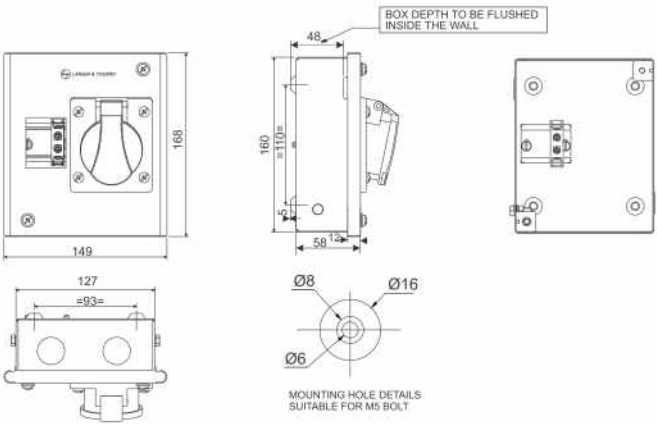

CAT No.	Description	Top/Bottom Knock out
		Ø25
DBPPS316SD	16A, 3Pin - 2MOD	2

## Plastic Plug & Socket DB

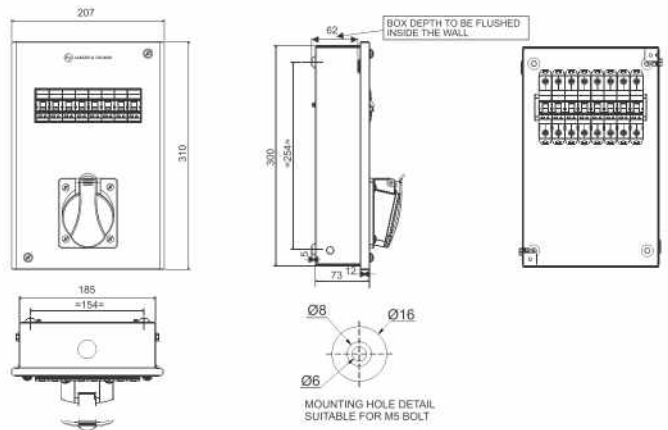

CAT No.	Description	Top/Bottom Knock out
		Ø25
DBPPS532SD	32A, 5Pin - 8MOD	2

## Plastic Plug & Socket DB

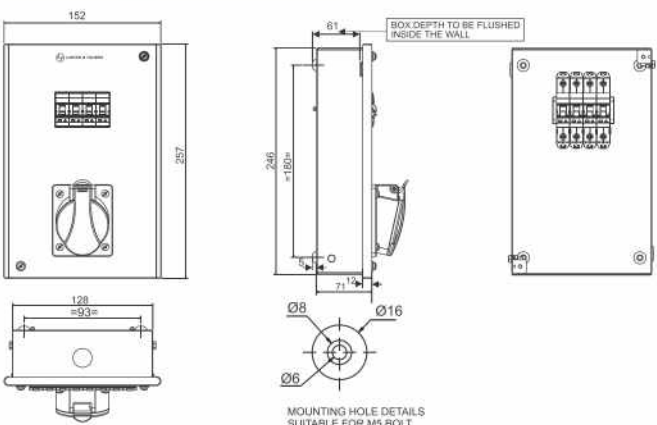

CAT No.	Description	Top/Bottom Knock out
		Ø25
DBPPS332SD	32A, 3Pin - 4MOD	2

## Plastic Plug & Socket DB

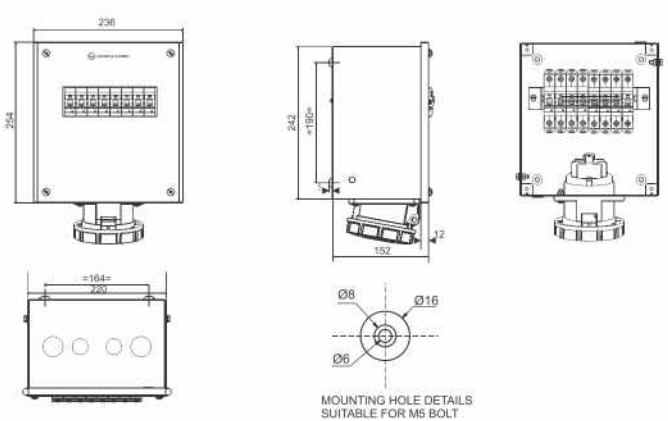

CAT No.	Description	Top/Bottom Knock out	
		Ø32	Ø25
DBPPS563SD	63A, 5Pin - 8MOD	2	2

UNLESS OTHERWISE SPECIFIED DIMENSIONS ARE IN mm  
TOLERANCE ON DIMENSIONS = ±2 mm

# Dimension Details Enclosures

## Enclosures

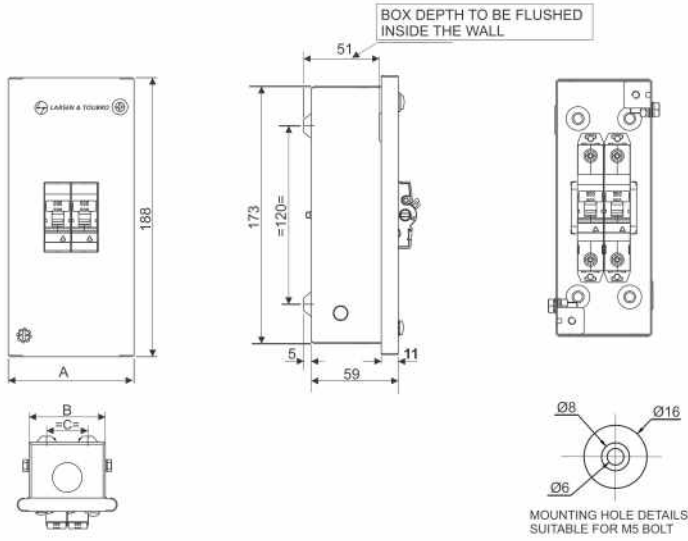

CAT No.	No. of Ways	A	B	C	Top/Bottom Knock out	
					Ø25	
DBENC002SD	2	85	65	35	1	
DBENC003SD	3	95	75	45	1	
DBENC004SD	4	105	85	55	1	
DBENC006SD	6	145	125	95	2	

# Dimension Details Cable end box

## Cable end box

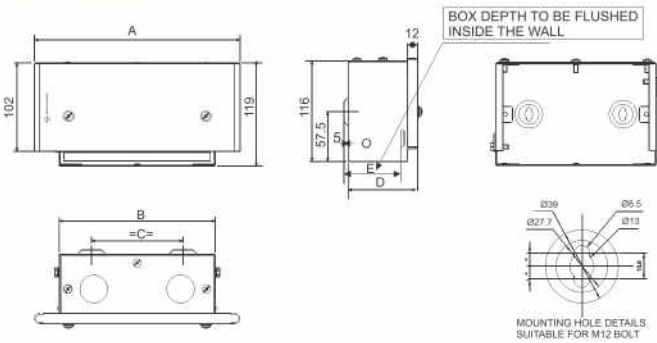

CAT No.	No. of Ways	A	B	C	D	E	Top/Bottom Knock out	
							Ø32	Ø25
DBTPE004CB	4	375	317	252	90	75	2	4
DBTPE006CB	6	412	357	292	90	75	2	4
DBTPN004CB	4	412	357	292	90	75	2	4
DBTPN006CB	6	451	398	332	90	75	2	6
DBTPN008CB	8	517	462	387	90	75	2	8
DBTPN012CB	12	710	655	584	90	75	2	12
DBTPN016CB	16	849	796	725	90	75	2	14
DBHPI004CB	4	489	444	383	94	79	2	6
DBHPI006CB	6	525	479	418	94	79	2	8
DBHPI008CB	8	595	549	487	94	79	2	9
DBHPI012CB	12	771	723	655	96	81	2	14
DBHPI016CB	16	916	868	800	96	81	2	18
DBTPI006CB	6	329	282	215	94	79	2	2
DBTPI008CB	8	379	332	265	94	79	2	4
DBTPI010CB	10	429	382	315	94	79	2	6
DBTPI012CB	12	479	432	365	94	79	2	6
DBTPI016CB	16	580	533	465	94	79	2	8
DBTPL012CB	12	480	433	325	117	102	2	6
DBROWX14CB	14	440	385	310	90	75	2	6
DBROWX16CB	16	480	425	350	90	75	2	6
DBPSG004CB	4	540	491	384	117	102	2	8
DBPSG006CB	6	646	596	489	117	102	2	10
DBPSG008CB	8	751	701	594	117	102	2	12
DBPSG012CB	12	961	911	804	117	102	2	18
DBPSR004CB	4	445	400	294	151	136	2	6
DBPSR006CB	6	480	435	329	151	136	2	6
DBPSR008CB	8	515	470	364	151	136	2	8
DBPSR010CB	10	550	505	399	151	136	2	8
DBPSR012CB	12	585	540	434	151	136	2	10

## Cable end box

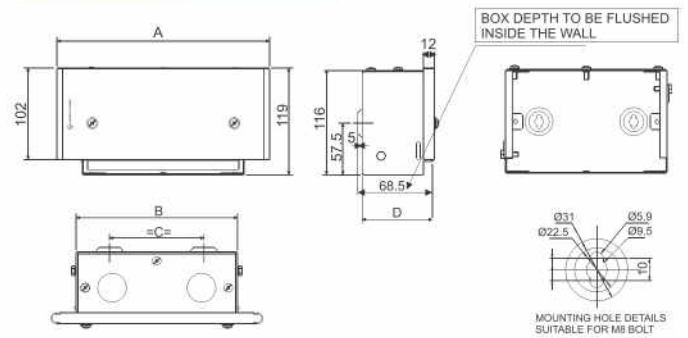

CAT No.	No. of Ways	A	B	C	D	Top/Bottom Knock out	
						Ø32	Ø25
DBSPN004CB	4	236	180	105	83	2	0
DBSPN006CB	6	271	215	140	83	2	2
DBSPN008CB	8	306	250	175	83	2	2
DBSPN012CB	12	376	320	245	83	2	4
DBSPN016CB	16	446	390	315	83	2	6
DBSPN018CB	18	481	425	350	83	2	6

## Cable end box

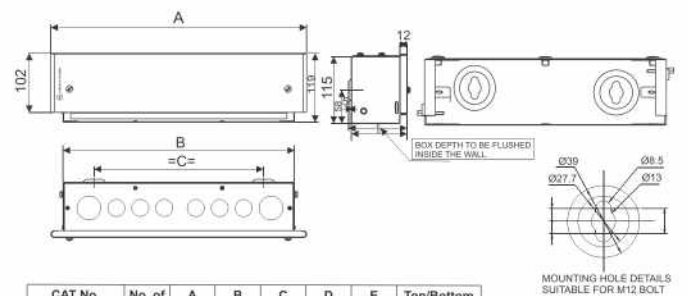

CAT No.	No. of Ways	A	B	C	D	E	Top/Bottom Knock out	
							Ø32	Ø25
DBVTMXXCB	-	447	400	293	100	86	2	6
DBVTXXXCB	-	487	440	293	115	102	2	6

UNLESS OTHERWISE SPECIFIED DIMENSIONS ARE IN mm  
TOLERANCE ON DIMENSIONS = ±2 mm

# DBs suitable for Aluminium shuttering (Mivan) Construction

## Dimension Details SPN DBs

IP 43 metal door

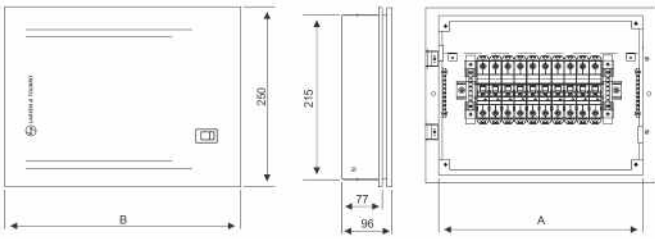

CAT No.	No. of Ways	A	B	Top/Bottom Knock out	
				Ø 25	
LTSD04M	4	180	247	3	
LTSD06M	6	220	287	4	
LTSD08M	8	250	317	5	
LTSD12M	12	320	387	7	
LTSD16M	16	400	467	9	

## Dimension Details TPN DBs

IP 43 metal door

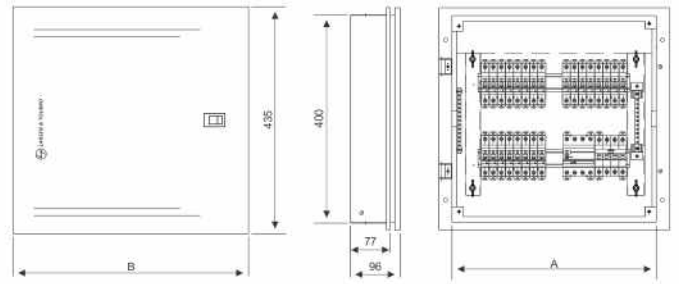

CAT No.	No. of Ways	A	B	Top/Bottom Knock out	
				Ø 25	
LTTD04M	4	360	427	8	
LTTD06M	6	390	457	8	
LTTD08M	8	430	497	9	

## DBs with provision for TV/Telephone splitters

### Dimension Details SPN DBs

IP 43 metal door

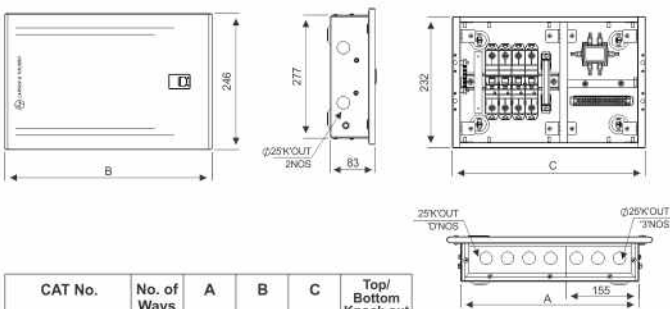

CAT No.	No. of Ways	A	B	C	Top/Bottom Knock out	
					Ø 25	
DBSPN06DDTV	6	365	433	407	4	
DBSPN08DDTV	8	400	468	442	5	
DBSPN12DDTV	12	470	538	512	7	

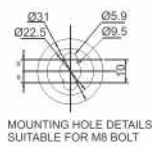

IP 43 metal door

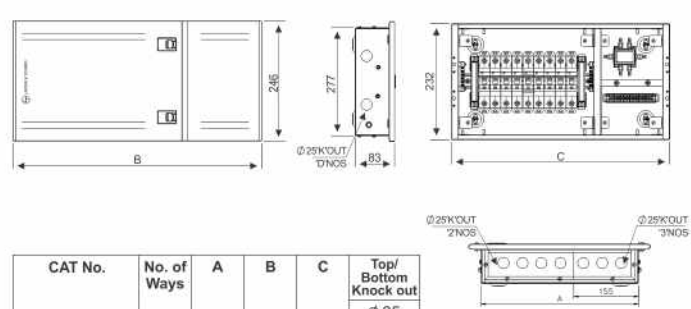

CAT No.	No. of Ways	A	B	C	Top/Bottom Knock out	
					Ø 25	
DBSPN16DDTV	16	540	608	582	8	
DBSPN18DDTV	18	575	644	617	9	



## Dimension Details TPN DB

IP 43 metal door

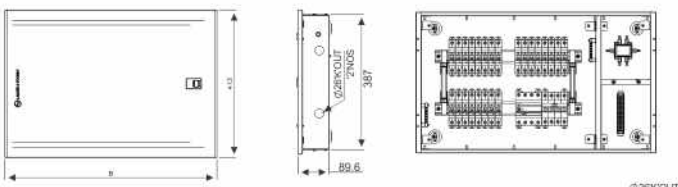

CAT No.	No. of Ways	A	B	Top/Bottom Knock out	
				Ø 25	Ø 32
DBTPN004DDTV	4	507	562	4	2
DBTPN006DDTV	6	548	603	6	2



IP 43 metal door

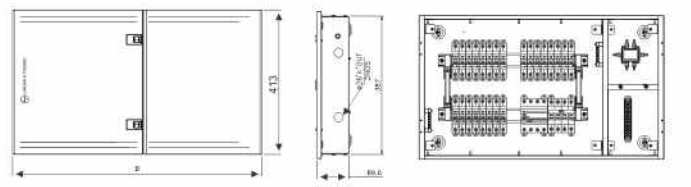

CAT No.	No. of Ways	A	B	Top/Bottom Knock out	
				Ø 25	Ø 32
DBTPN008DDTV	8	612	669	8	2



UNLESS OTHERWISE SPECIFIED DIMENSIONS ARE IN mm  
TOLERANCE ON DIMENSIONS = ±2 mm



## General Terms

All prices are on maximum retail price basis inclusive of all Duties, GST and any other Tax as applicable.

Prices are subject to revision without notice.

## Warranty Policy

All the products listed in the price list carry a warranty, against manufacturing defects for a period of 18\* months from the date of purchase.

Should the product prove to be defective due to faulty workmanship or otherwise, we will remedy the defect or replace the faulty parts or the whole product at our discretion, as soon as possible, free of cost.

The warranty is however subject to the provision of proper usage, efficient maintenance and does not cover defects arising out of fire, accident, inefficient maintenance, faulty operation and willful or accidental damage. It also does not cover damage to power electronic components like thyristors & IGBTs, which fail predominantly due to over-temperature & over-voltage. The user needs to take adequate precautions to eliminate these conditions. The manufacturer shall not be liable for any consequential loss, injury or damages attributable to defect or failure of its products.

## Comprehensive Service Support

L&T has over five decades of experience in providing after sales service for low voltage distribution systems in every type of industry & commercial complex in India.

L&T offers the following services, partnering you in your maintenance of low voltage distribution products :

- Regular Maintenance
- Preventive Maintenance Programme
- On Call
- Annual Maintenance Contract
- Product Support for Managing Obsolescence - Retrofitting & Upgradation of your switchgear products.

\* Proof of purchase to be retained to avail warranty

## Electrical Standard Products (ESP) Offices:

### HEAD OFFICE

L&T Business Park,  
Tower 'B' / 3rd Floor  
Saki Vihar Road, Powai  
**Mumbai 400 072**  
Tel: 022-67053229  
Fax: 022-67051112  
e-mail: cic@LNTEBG.com

### BRANCH OFFICES

501, Sakar Complex I  
Opp. Gandhigram Rly. Station  
Ashram Road  
**Ahmedabad 380 009**  
Tel: 079-66304006-11  
Fax: 079-66304025  
e-mail: esp-ahm@LNTEBG.com

38, Cubbon Road, P. O. Box 5098  
**Bengaluru 560 001**  
Tel: 080-25020100 / 25020324  
Fax: 080-25580525  
e-mail: esp-blr@LNTEBG.com

131/1, Zone II  
Maharana Pratap Nagar  
**Bhopal 462 011**  
Tel: 0755-3080511 / 05 / 08 / 13 / 17 / 19  
Fax: 0755-3080502  
e-mail: esp-bho@LNTEBG.com

Plot No. 559, Annapurna Complex  
Lewis Road  
**Bhubaneswar 751 014**  
Tel: 0674-6451342 / 2436690 / 2436696  
Fax: 0674-2537309  
e-mail: esp-bsr@LNTEBG.com

Aspire Towers, 4th Floor  
Plot No. 55, Phase-I  
Industrial & Business Park  
**Chandigarh-160 002**  
Tel: 0172-4646840 / 41 / 42 / 46 / 53  
Fax: 0172-4646802  
Email: esp-chd@Lntebg.com

L&T Construction Campus  
TC-1 Building, II Floor  
Mount-Poonamallee Road  
Manapakkam  
**Chennai 600 089**  
Tel: 044-2270 6800  
Fax: 044-22706940  
e-mail: esp-maa1@LNTEBG.com

67, Appuswamy Road  
Post Bag 7156  
Opp. Nirmala College  
**Coimbatore 641 045**  
Tel: 0422-2588120 / 1 / 5  
Fax: 0422-2588148  
e-mail: esp-cbe@LNTEBG.com

Khairasol, Degaul Avenue  
**Durgapur 713 212**  
Tel: 0343-2540448 / 2540449 / 2540443  
Fax: 0343-2540442  
e-mail: esp-dgp@LNTEBG.com

5, Milanpur Road, Bamuni Maidan  
**Guwahati 781 021**  
Tel: +91 8876554417  
Fax: 361-2551308  
e-mail: esp-ghy@LNTEBG.com

II Floor, Vasantha Chambers  
5-10-173, Fateh Maidan Road  
**Hyderabad 500 004**  
Tel: 040-67015052  
Fax: 040-23296468  
e-mail: esp-hyd@LNTEBG.com

Monarch Building, 1st Floor  
D-236 & 237, Amrapali Marg  
Vaishali Nagar  
**Jaipur 302 021**  
Tel: 0141-4385914 to 18  
Fax: 0141-4385925  
e-mail: esp-jai@LNTEBG.com

Akashdeep Plaza, 2nd Floor  
P. O. Golmuri  
**Jamshedpur 831 003**  
Jharkhand  
Tel: 0657-2312205 / 38  
Fax: 0657-2341250  
e-mail: esp-jam@LNTEBG.com

Skybright Bldg; M. G. Road  
Ravipuram Junction, Ernakulam  
**Kochi 682 016**  
Tel: 0484-4409420 / 4 / 5 / 7  
Fax: 0484-4409426  
e-mail: esp-cok@LNTEBG.com

3-B, Shakespeare Sarani  
**Kolkata 700 071**  
Tel: 033-42005982  
Fax: 033-22821025 / 7587  
e-mail: esp-ccu@LNTEBG.com

A28, Indira Nagar, Faizabad Road  
**Lucknow 226 016**  
Tel: 0522-4929905 / 04  
Fax: 0522-2311671  
e-mail: esp-Lko@LNTEBG.com

No: 73, Karpaga Nagar, 8th Street  
K. Pudur  
**Madurai 625 007**  
Tel: 0452-2567405 / 2561068 / 2561657  
Fax: 0452-2567552  
e-mail: esp-mdu@LNTEBG.com

L&T Business Park,  
Tower 'B' / 5th Floor  
Saki Vihar Road, Powai  
**Mumbai 400 072**  
Tel: 022-67052874 / 2737 / 1156  
Fax: 022-67051112  
e-mail: esp-bom@LNTEBG.com

12, Shivaji Nagar  
North Ambajhari Road  
**Nagpur 440 010**  
Tel: 0712-2260012 / 6606421  
Fax: 2260030 / 6606434  
e-mail: esp-nag@LNTEBG.com

32, Shivaji Marg  
P. O. Box 6223  
**New Delhi 110 015**  
Tel: 011-41419514 / 5 / 6  
Fax: 011-41419600  
e-mail: esp-del@LNTEBG.com

L&T House  
P. O. Box 119  
191/1, Dhole Patil Road  
**Pune 411 001**  
Tel: 020-66033395 / 66033279  
Fax: 020-26164048 / 26164910  
e-mail: esp-pnq@LNTEBG.com

Crystal Tower,  
4th Floor, G. E. Road  
Telibandha  
**Raipur - 492 006**  
Tel: 0771-4283214  
e-mail: esp-raipur@LNTEBG.com

3rd Floor  
Vishwakarma Chambers  
Majura Gate, Ring Road  
**Surat 395 002**  
Tel: 0261-2473726  
Fax: 0261-2477078  
e-mail: esp-sur@LNTEBG.com

Radhadaya Complex  
Old Padra Road  
Near Charotar Society  
**Vadodara 390 007**  
Tel: 0265-6613610 / 1 / 2  
Fax: 0265-2336184  
e-mail: esp-bar@LNTEBG.com

Door No. 49-38-14/3/2, 1st floor,  
NGGO's Colony, Akkayyapalem,  
**Visakhapatnam - 530 016**  
Tel: 0891-2791126 / 2711125  
Fax: 0891-2791100  
Email: esp-viz@LNTEBG.com

Product improvement is a continuous process. For the latest information and special applications, please contact any of our offices listed here. Product photographs shown are for representative purpose only.

**L&T SWITCHGEAR**  
SAFE & SURE

 **LARSEN & TOUBRO**

**Larsen & Toubro Limited, Electrical Standard Products**  
Powai Campus, Mumbai 400 072

### Customer Interaction Center (CIC)

BSNL / MTNL (toll free) : 1800 233 5858 Reliance (toll free) : 1800 200 5858  
Tel : 022 6774 5858 E-mail : cic@Lntebg.com  
Website : www.Lntebg.com

**Registered Office:** L&T House, N. M. Marg, Ballard Estate, Mumbai 400 001, INDIA **CIN:** L99999MH1946PLC004768